



A M C R E S T

**Amcrest IP5M-D1188EW-28MM
5MP POE Dome Camera
User Manual**

**Version 1.0.0
Revised December 29th, 2020**

Contents

Welcome	3
Important Security Warning	3
Important Safeguards and Warnings.....	3
Features and Specifications	4
Overview	4
Features	4
Device Overview	5
Connection & Installation	5
Connection Guide	5
Installation Guide.....	6
MicroSD Card Installation	7
Camera Access Setup.....	7
Default Username and Password	8
How to Setup the Camera	8
App Setup.....	8
Desktop Access Setup.....	13
Operation and Interface	14
Live	14
Playback.....	15
Setup	16
Camera.....	17
Event	30
Storage.....	36
Destination.....	39
System.....	42
Information	46
Alarm.....	48
Logout	48
Remote Web Access Setup	48
Amcrest Cloud Desktop Setup	51
Web Access Setup (AmcrestView.com).....	51
FAQs/Troubleshooting.....	51
Glossary of Terms	53
FCC Statement	54
IC Warning Statement	55
Appendix A: Toxic or Hazardous Materials or Elements	55

Welcome

Thank you for purchasing an Amcrest camera!

This user manual is designed to be a reference tool for the installation and operation of your camera. Here you can find information about the camera's features, functions, and information to aid in troubleshooting.

Many of the setup and installation sections below have corresponding videos on YouTube. To access the setup videos, please go to <http://amcrest.com/videos>



For access to the quick start guide and other support information, go to <http://amcrest.com/support>. To contact Amcrest support, please do one of the following:

Visit <http://amcrest.com/contacts>

Important Security Warning

To keep your Amcrest camera secure and prevent unauthorized access, please make sure to follow the steps below:



- Always make sure that your camera has the latest firmware as listed on www.amcrest.com/firmware
- Never use the default password for your camera. Always ensure that your password is at least 8-10 characters long and contains a combination of lowercase characters, uppercase characters as well as numbers.

Important Safeguards and Warnings

1. Electrical Safety

All installation and operation should conform to your local electrical safety codes.

The product must be grounded to reduce the risk of electric shock.

We assume no liability or responsibility for any fires or electrical shock caused by improper handling or installation.

2. Transportation Security

Heavy stress, violent vibrations, and excess moisture should not occur during transportation, storage, and installation of the device.

3. Installation

Handle the device with care. Keep the device right side up.

Do not apply power to the camera before completing installation.

Do not place objects on top of the camera.

4. Repair Professionals

All the examination and repair work should be done by qualified service engineers. We are not liable for any problems caused by unauthorized modifications or user-attempted repair.

5. Environment

The camera should be kept in a cool, dry place away from direct sunlight, flammable materials, explosive substances, etc.

This product should be transported, stored, and used only in the specified environments as stated above. Do not aim the camera at a strong light source, as it may cause overexposure of the picture, and may affect the longevity of the camera's sensors.

Ensure that the camera is in a well-ventilated area to prevent overheating.

6. Operation and Maintenance

Do not touch the camera sensor or lens directly.

To clean dust or dirt from the lens, use an air blower or a microfiber cloth.

7. Accessories

Be sure to use only the accessories recommended by manufacturer.

Before installation, please open the package and check to ensure that all the components are present. Contact the retailer that you purchased from, or Amcrest directly if anything is broken or missing in the package.

Features and Specifications

Overview

Amcrest provides an excellent digital surveillance product that can be useful to a wide variety of users. This camera connects uses an internet connection to allow the user to access all its features. It is easy to use and can be viewed on a computer via the built-in web user interface or on your smartphone using the Amcrest View Pro app.

This camera adopts a high-quality design to achieve high levels of reliability and security. It can be configured to work locally, as well as on a network. This camera works using a POE connection and interfaces with most networks through the Ethernet port of your router, POE injector or POE switch.

Features

This camera has the following features:

Network Access

The camera can be accessed remotely from a wide variety of internet connected devices, including PCs, Mac, iOS, and Android devices.

Cloud Storage Functionality

Amcrest offers premium cloud storage options to enable long-term storage. Amcrest Cloud also allows the user to easily locate and view recordings for playback from any internet connected computer or smartphone (iOS/Android).

Advanced Network Protocol Support

This camera is UPnP compatible, and includes functionality for use with DDNS, and other protocols to allow remote and local connection with a large variety of network hardware.

IMPORTANT: Due to specific hardware limitations within your camera it is important to note that these devices will not be able to automatically pan/tilt or pivot in either the app or via the web UI on a computer. For this reason, it

is imperative to make sure to mount the cameras properly and position them as efficiently as you can to the areas you wish to monitor. All positioning actions to the camera will have to be performed manually.

Device Overview

The image below shows the structure of the camera:

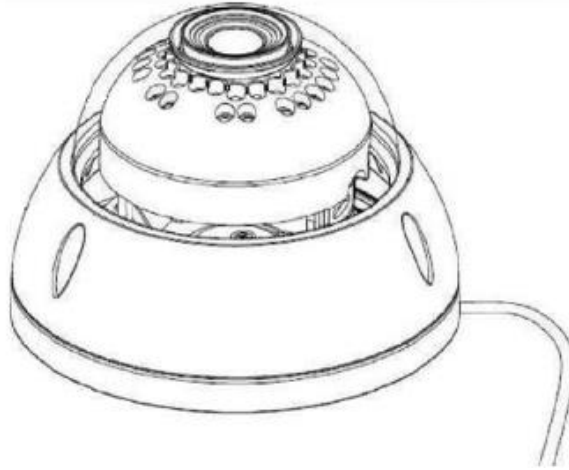

The images below show the dimensions for the camera. The measurements are in millimeters (mm):

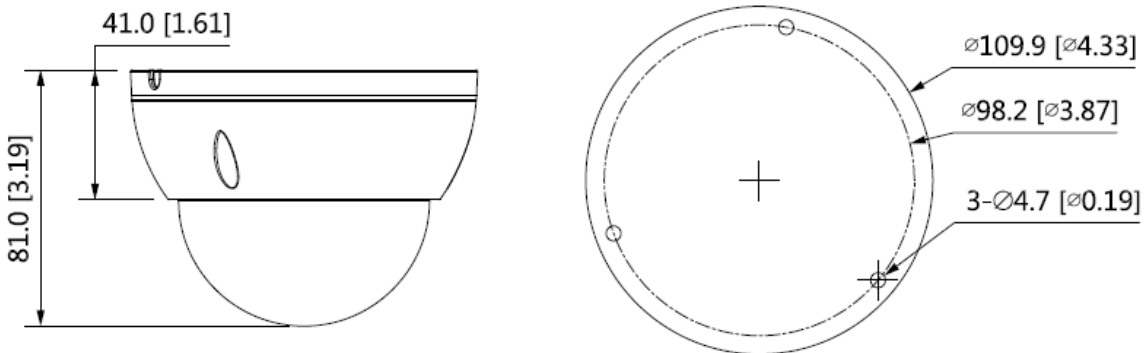

To access the reset button, microSD card slot, or to manually adjust the camera angle, use a Torx/Hex wrench to open the camera assembly by removing the 3 screws.

For reference, a Torx/Hex screwdriver tip looks like this: 

Connection & Installation

This section provides information about the connection and installation of your camera.

Connection Guide

The camera initially should be connected via the following method:

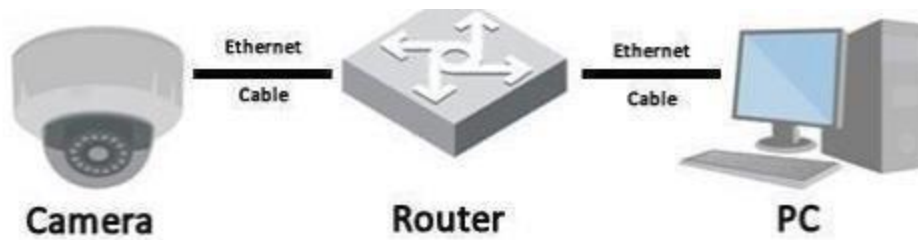

Once connected to a PC or mobile device you will be able to configure the device to your network. For more information.

Installation Guide

To install the camera on a ceiling or wall, please reference the below diagram as well as the steps:

Note: Prior to installation, please ensure that the installation environment can support at least 3x the weight of the camera and bracket.

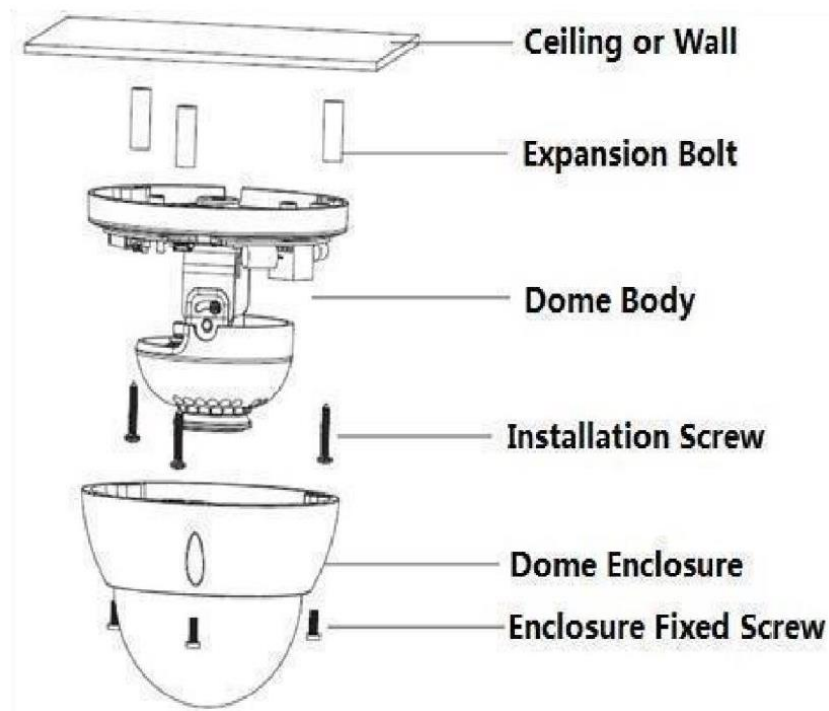

Note: Due to specific hardware limitations within your camera it is important to note that these devices will **not be able to automatically pan/tilt or pivot in either the app or via the web UI on a computer.**

For this reason, it is imperative to make sure to mount the cameras properly and position them as efficiently as you can to the areas you wish to monitor. All positioning actions to the camera will have to be performed manually.

To install the camera onto a wall, follow the steps below:

1. Use a Torx/Hex wrench (included) to open the dome enclosure by unfastening the three inner hex screws on enclosure.
 2. Place the installation sticker on the wall or ceiling surface that you wish to mount your camera.
 3. Using the X's on the installation sticker, drill 3 holes to allow for the insertion of the included expansion bolts.
 4. If the camera's cable will be exiting through the wall or ceiling surface, please be sure to drill an exit hole and pull the cable through.
 5. If the camera's cable will be exiting through the side of the camera, route the cable through the U-shaped channel on the side of the enclosure.
 6. Align the camera with the installation sticker, then line up the 3 screw holes in the camera pedestal to the three plastic expansion bolts on the installation surface. Put the three included screws through the camera then insert them into the expansion bolts firmly.
 7. Adjust the camera in the position that you want it to be in, then reattach the dome body to the base of the camera.
- Note:** Range of lens: vertical (0°~+65°), horizontal (0°~+355°). When adjusting the camera into position, please ensure that the camera's enclosure does not block the image or cause reflection of IR light.

MicroSD Card Installation

A microSD card can be used to store and view local recordings/snapshots. This camera requires a class 10 or above microSD card formatted to FAT32 to function. The camera can handle a max of 256GB of microSD card storage.

Note: You will need to access the camera's motherboard to insert the microSD card.

1. Remove the lens cover for the camera with the supplied wrench tool to access the motherboard.
2. Locate the provided microSD card slot on the motherboard and slide the clasp back to open.
3. Place the microSD card, into the provided microSD card slot gold pins down and close the clasp.
4. Slide the clasp forward to secure the microSD card to the pins and secure the clasp.

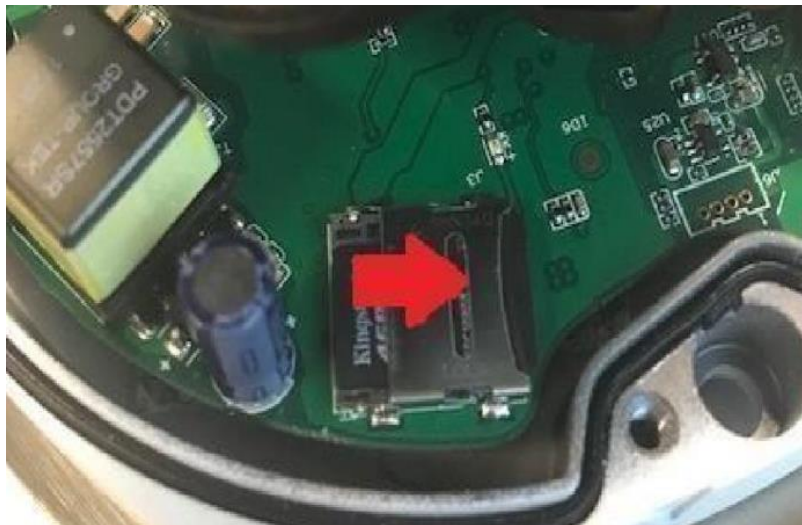

Camera Access Setup

This section will provide information on how to setup and access your camera through the following methods:

Local PC (Web User Interface (Web UI), Amcrest Surveillance Pro, etc.)

Amcrest View Pro app
Amcrest Surveillance Pro
Amcrest Cloud

Default Username and Password

To login to the system for the first time, use one of the following default username/password combinations. Once you have successfully logged in, it is highly recommended to change the password for security reasons.

Username: admin

Password: admin

Note: Logging in for the first time will prompt the user to change the password to the admin account.

How to Setup the Camera

To make your experience with your Amcrest camera easy and simple, we've provided multiple ways to set up, view, and operate your camera depending on your needs. Please follow the instructions on this page to set up your camera in the way that works best for you.

Setting up Your Camera for the First Time

If you are setting up your camera for the first time, or you are setting up your camera for mobile viewing. Using the Amcrest Cloud app or Amcrest View app on your smartphone or tablet, you can view your camera live from anywhere, and access features such as taking snapshots, creating recordings, and more.

For Configuring Advanced Settings on Your Camera

If you would like to configure your camera to enable advanced features such as motion direction, e-mail alerts, FTP, image adjustments, scheduling and more.

For Cloud Storage and Playback

Amcrest Cloud is our optional cloud storage and playback service which allows you to access recorded footage from any device. Amcrest Cloud offers both motion detection and continuous storage plans to fit your needs. For more information on the Amcrest Cloud, please visit: <https://amcrest.com/cloud/>

For Quick Web Access to Your Cameras

AmcrestView.com is a web portal that allows you to view your cameras and recordings quickly and easily from anywhere in the world using a web browser. Use AmcrestView.com if you need to simply check-in at a moment's notice. If you would like to use AmcrestView.com.

App Setup

Amcrest cameras can be used on your mobile device using the following apps:

- Amcrest Cloud
- Amcrest View Pro

Both apps are free and available in the App Store and Google Play store. Please note, each app requires an iOS 6.0 or later version. Android will require a 3.0 or later version OS to run these apps.

For purposes of this guide, we will use iOS, though both apps. The App Interface may differ slightly from the screenshots below as updates are released. Below, you will find instructions on how to set up your camera up on the Amcrest cloud app as well as the Amcrest View Pro app.

Amcrest Cloud App Setup

Amcrest Cloud allows you to access your device from anywhere in the world. Please note, you will need an Amcrest Cloud account to proceed with Amcrest Cloud app setup. You can register for a cloud account in the Amcrest Cloud app or from the Amcrest Cloud website at amcrestcloud.com

- Please make sure your camera is plugged into a power source and your Ethernet cable is connected from the camera to your router.
- Make sure your camera and mobile device are on the same network during setup.
- To ensure the camera connects to the cloud, a reboot of your camera is recommended. To add your camera onto the Amcrest Cloud app, follow these steps:

1. Download and open the Amcrest Cloud app from the App Store or Play Store.

Note: Connect your mobile device to the same network that your camera is on.

2. Register for an Amcrest Cloud account. To register click on **Sign Up** and fill out the form to complete registration.

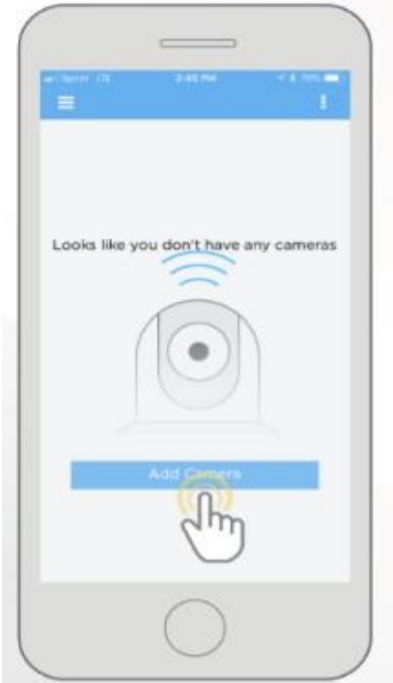
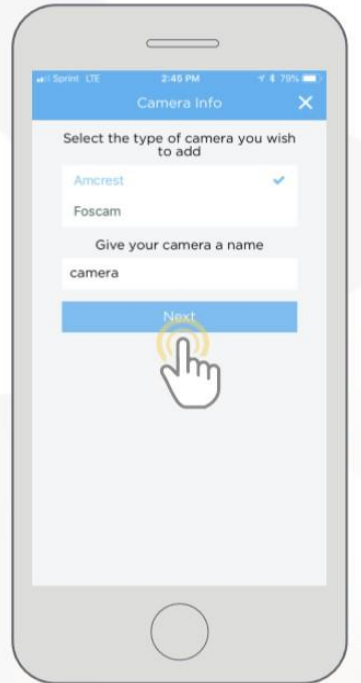
	
<p>3. Tap on Add Camera</p>	<p>4. Give your camera a name (Ex. Garage, Living Room, Kitchen, etc.) and tap Next to continue.</p>

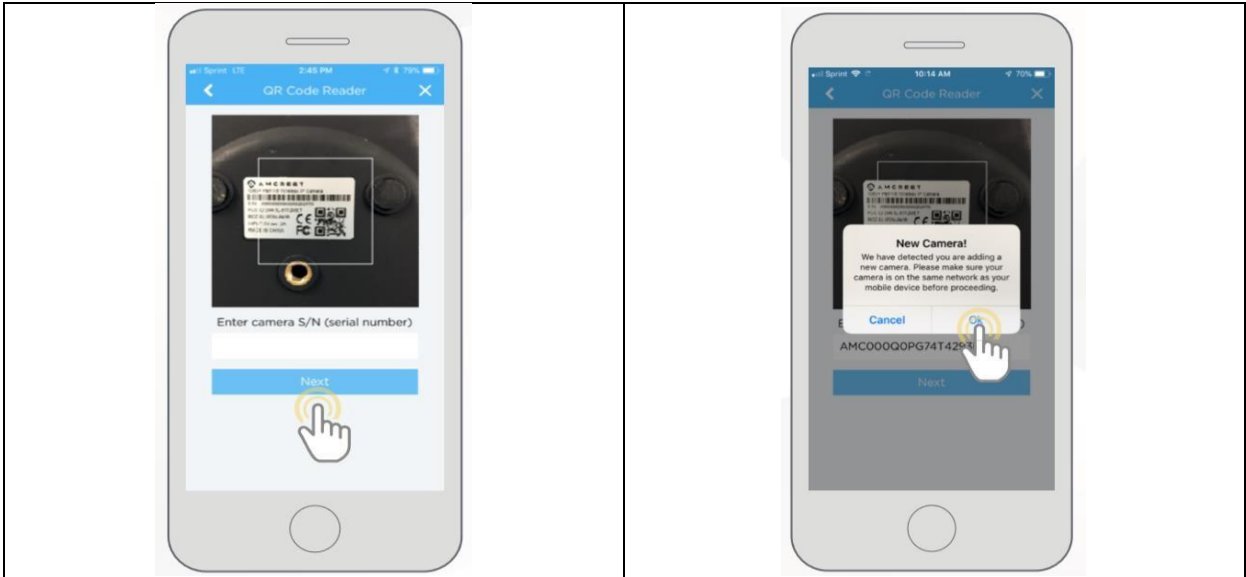

5. Scan the QR code  on the back/side/bottom of the camera or manually enter the camera's serial number into the **Enter camera S/N (serial number)** field. Press **Next** to continue.

6. If you are adding a new camera that does not have a set password the app will automatically detect that a new camera is being added. Tap **OK** to proceed.

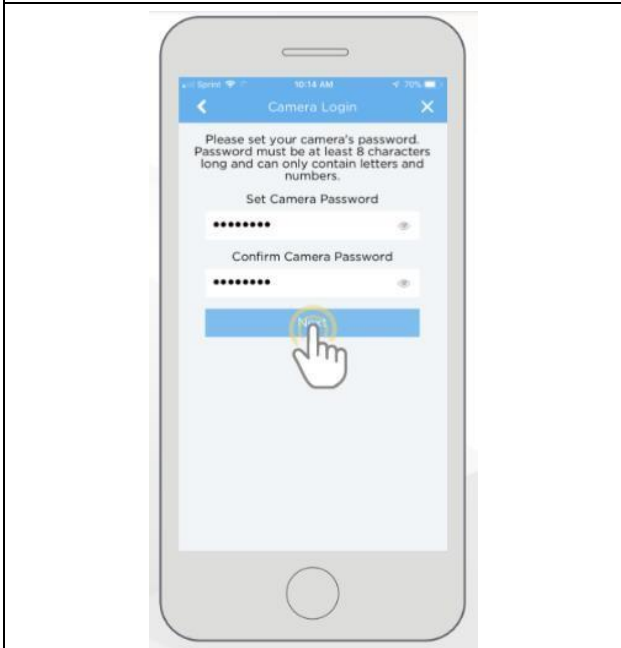

7. Set a new password for your camera. The password must be between 8 to 32 characters long and contain only letters and numbers. When you have finished setting the password for your camera, enter the password again in the **Confirm Camera Password** section. Tap **Next** to continue.

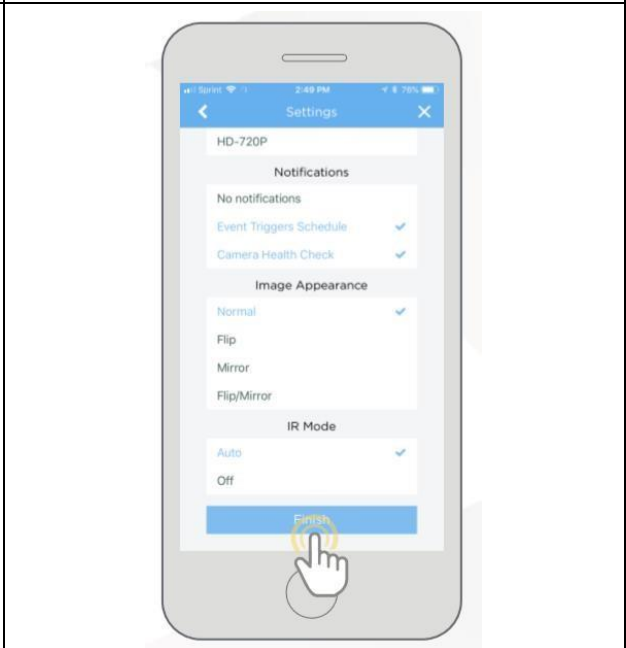

8. Confirm and adjust any needed settings for your camera. When all settings have been confirmed, tap **Finish**.

For more information about the Amcrest Cloud app and its features, visit amcrest.com/support

Amcrest View Pro Setup

To add your PoE camera to the Amcrest View Pro app follow these steps:

The following steps will continue the app setup process for an Android phone and, though the iPhone version of the app has slightly different steps, most of this process is identical and easy.

Download and install the Amcrest View Pro app for the App Store or Google Play Store.



Open the app on your mobile device and allow the app to load.

<p>Tap "Start".</p>	<p>Tap "POE Camera".</p>

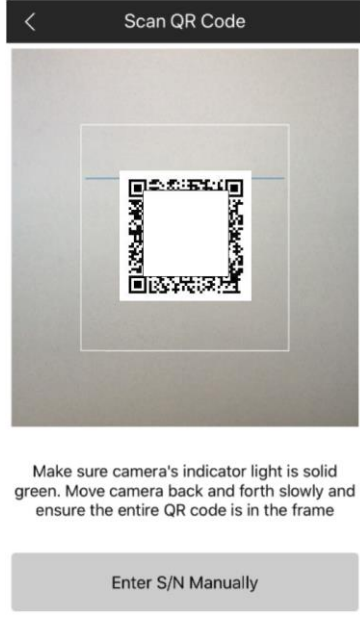
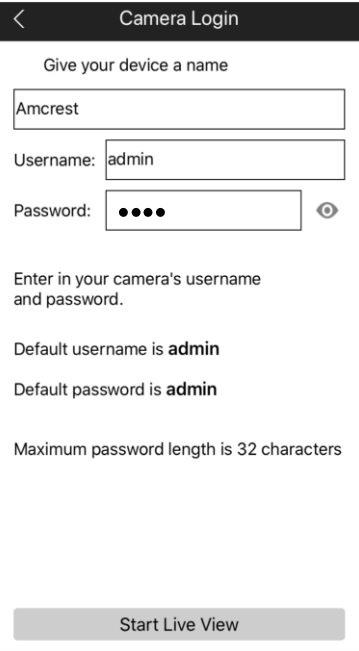
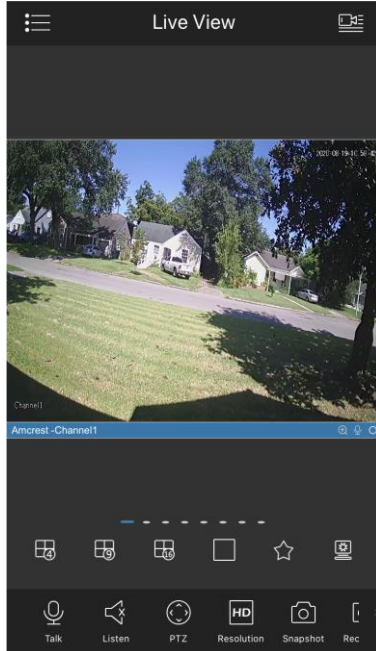
 <p>Please connect your device to the Internet via an ethernet connection to your router before starting setup</p> <p>P2P Setup: Tap the button below to setup your device using P2P Setup access.</p> <p>IP/Domain/DDNS Setup: Tap the button below to set up your device for IP/Domain/DDNS access.</p>	 <p>Make sure camera's indicator light is solid green. Move camera back and forth slowly and ensure the entire QR code is in the frame</p>
<p>Tap “P2P Connection”.</p> <p>Note: IP/Domain/DDNS can be used to establish a DDNS connection. For more information on how to setup a DDNS connection, visit amcrest.com/support</p>	<p>Scan the QR code. The QR code can be found on the serial tag along with a scannable barcode.</p>
 <p>Give your device a name</p> <p>Username: admin</p> <p>Password: ●●●●</p> <p>Enter in your camera's username and password.</p> <p>Default username is admin</p> <p>Default password is admin</p> <p>Maximum password length is 32 characters</p>	
<p>Create a name for the device and enter a username and password. The default username and password will be admin.</p> <p>Tap “Start Live View”.</p>	<p>Update the default password for the device and tap “Start Live View” to view the device.</p>

For more information about Amcrest View Pro and its functionalities visit amcrest.com/support

Desktop Access Setup

The features associated with your camera are only accessible and customizable using the built-in web user interface via a web browser.

This camera features the latest in JS technology which allows you to access your camera via a wide variety of web browsers including, Google Chrome, Firefox, Safari and other mainstream web browsers via your PC or Mac computer. For more information on how to access your camera from your computer please refer to the information below.

To access your camera from your computer you will need to first locate the camera's IP address. To locate the camera's IP address is it highly recommended to download our free Amcrest IP Config Tool software. The Amcrest IP Config Tool can be downloaded at the following web page: amcrest.com/downloads

In the **All Downloads** menu, click on **IP Config Software** to begin the free download. Once the download has completed installing, locate the IP address associated with the device you would like to view in the browser.

Open a web browser and enter this IP address for your camera into browser and press Enter.

In the web user interface, enter the login credentials for your device. If this is the first time accessing the device, the username and password will both be **admin**. Click on **Login**.



If this is the first-time logging into your device, you will be prompted to modify the password for your device. To modify the password, enter the new password you would like to use in the **New Password** field and confirm. The password used should be between 8 and 32 characters long with a combination of letters and numbers.



Click **OK** when and allow the stream to load.

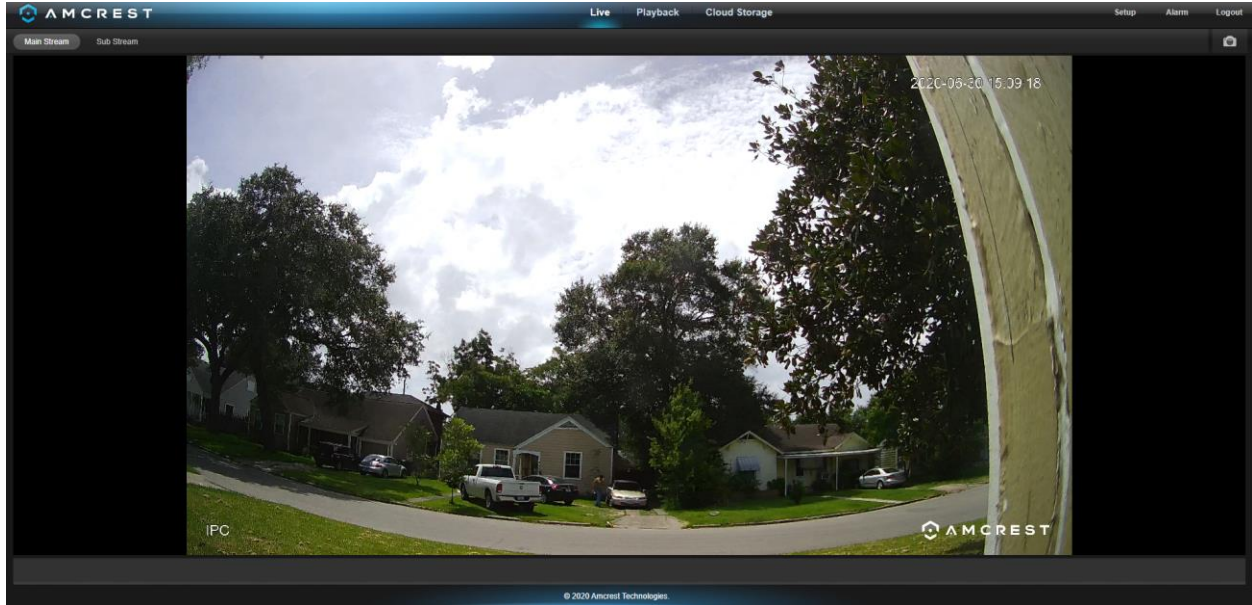

Operation and Interface

This section will show you the basic operation and interfaces of the web user interface for your camera.

Live

By default, the interface opens on the Live tab. The live view tab allows the user to see a live video feed from the camera. The live view tab has five main sections:



Section 1: These options allow the user quick access to the live view screen, playback, as well as to Amcrest Cloud.

Section 2: This section allows the user to switch between Main Stream and Sub Stream.

Section 3: This is the live view feed from the camera.

Section 4: This section allows the user to access setup options, alarms, and logout the interface.

Section 5: This option allows the user to take a snapshot of the live view screen.

Playback

The Playback tab allows the user to playback the camera's recorded video. Please note, if you are using a main stream web browser, such as Google Chrome, some playback options may be limited. Below is a screenshot of the Playback tab:

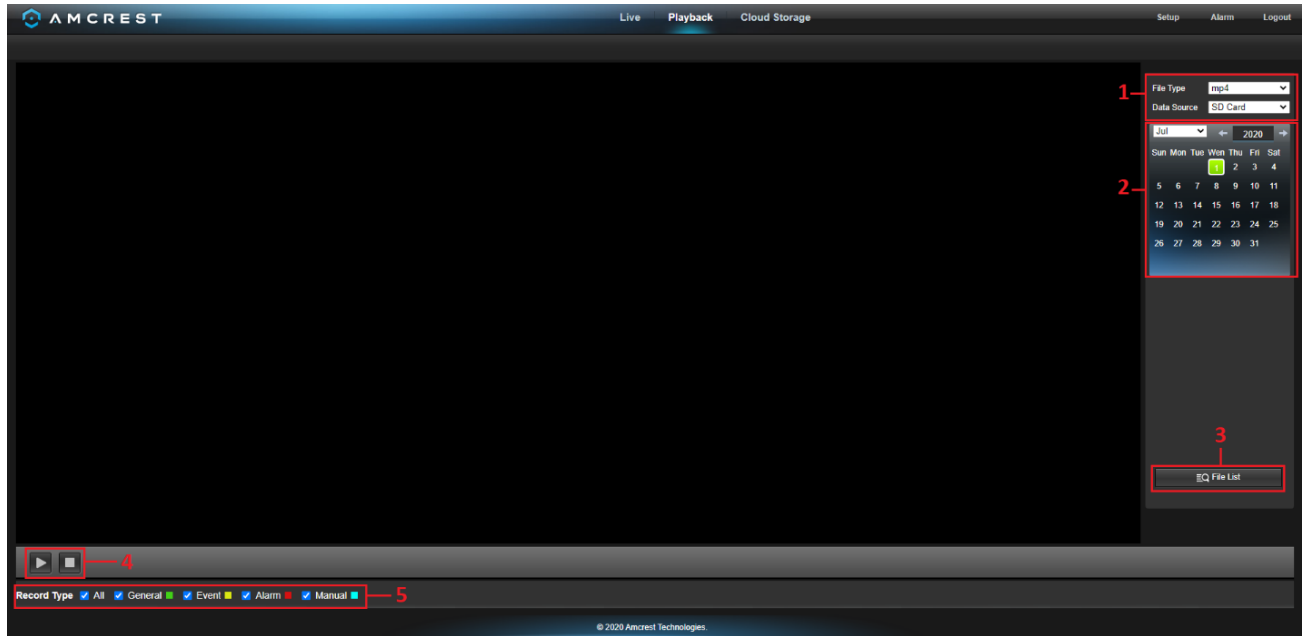

This is the interface for the playback menu. There are 5 main sections:

Section 1: Allows the user to filter between video (.mp4) or snapshots (.jpg).

Section 2: Allows the user to playback events based on calendar dates. If events are detected via the microSD card the days will be highlighted indicating recordings are available for that day.

Section 3: The File List option provides a list of all recorded file types reported on a specific day. The files represented in the file list can be played back and downloaded from this menu.

Section 4: Once a recording is selected from the file list, use the play, and stop button to play or stop the recording. An additional slider option will be displayed by hovering the mouse pointer over the playback interface.



Section 5: These options allow the user to filter between recording types such as, General, Motion, Alarm, or Manual events. The “All” option will select all recording types in the interface.

Cloud Storage

The Cloud Storage tab allows the user quick access to the Amcrest Cloud website.

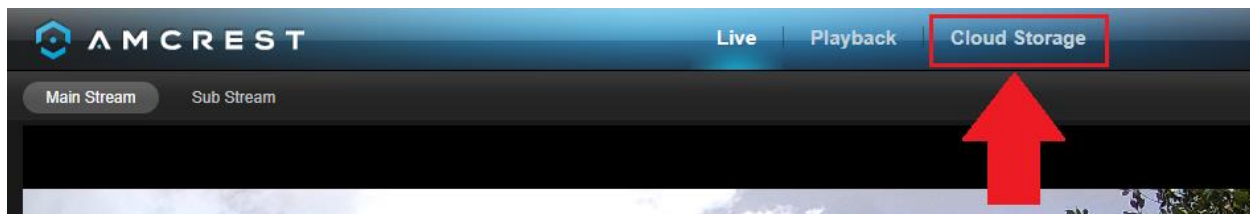

At this website (amcrestcloud.com) users can register for new accounts as well as view or modify existing accounts. For more information on Amcrest Cloud visit: amcrest.com/cloud

Setup

The Setup tab allows the user to change different camera settings. Below is a screenshot of the setup tab:

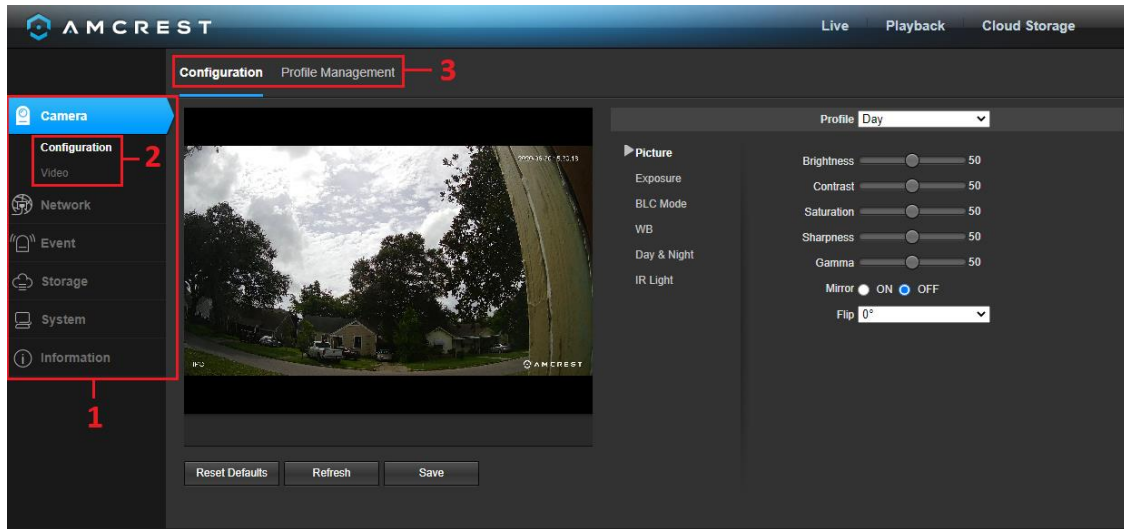

There are 3 main sections to note in the Setup tab:

1. **Menu Bar:** Allows the user to switch between Configuration and Profile Management options.
2. **Menu Items:** Each menu option opens a different menu which allows the user to change between specific settings configurations.
3. **Menu Tab:** Displays menu items pertaining to the selected tab.

Camera

This menu tab allows the user to change different camera settings for video and to manage image profiles.

Configuration

The Configuration menu allows the user to configure image profiles for normal, day, and night usage.

Below is a screenshot that shows the Configuration tab in the Configuration menu item:

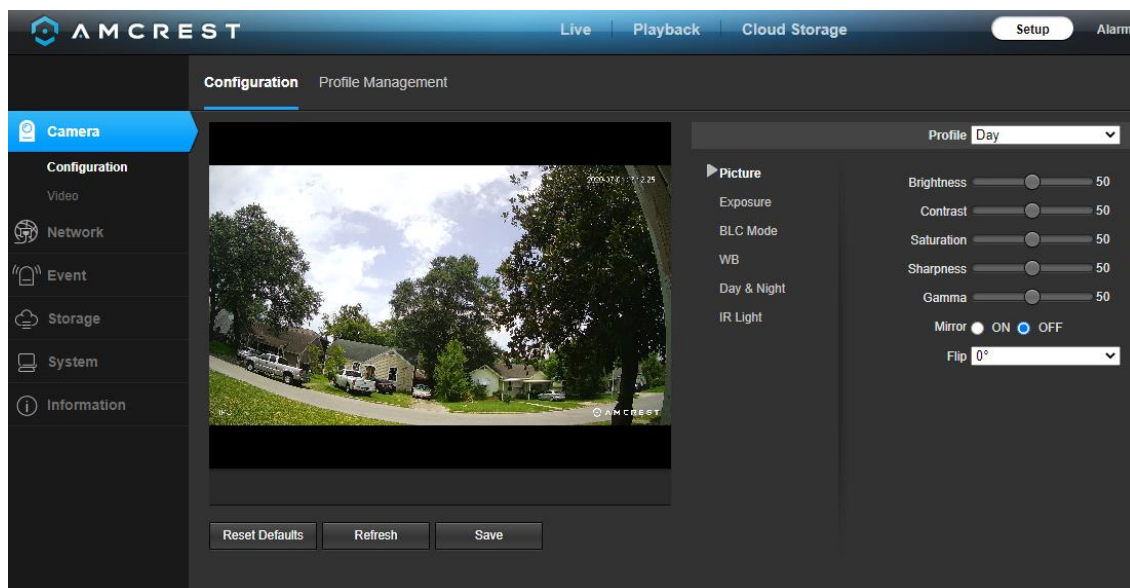

Below is an explanation for each of the fields on the Configuration tab in the Configuration menu item:

Picture

Profile: This dropdown box allows the user to select which profile to modify. The 3 options are Day, Night, and General.

Brightness: This slider is used to adjust playback and recorded video window brightness. The value ranges from 0 to 100. The default value is 50. The larger the number, the brighter the video is. When you input the value here, the bright section and the dark section of the video will be adjusted accordingly. You can use this function when the whole video is too dark or too bright. Please note the video may become hazy if the value is too high. The recommended value ranges from 40 to 60.

Contrast: This slider is used to adjust playback and recorded video window contrast. The value ranges from 0 to 100. The default value is 50. The larger the number is, the higher the contrast is. You can use this function when the whole video brightness is OK, but the contrast is not correct. Please note the video may become hazy if the value is too low. If this value is too high, the dark section may lack brightness while the bright section may overexpose. The recommended value ranges from 40 to 60.

Saturation: This slider is used to adjust playback and recorded video window saturation. The value ranges from 0 to 100. The default value is 50. The larger the number, the stronger the color is. This value has no effect on the general brightness of the whole video. The video color may become too strong if the value is too high. For the grey part of the video, distortion may occur if the white balance is not accurate. Please note the video may not be clear if the value is too low. The recommended value ranges from 40 to 60.

Sharpness: This slider is used to adjust the sharpness of the video. The value ranges from 0 to 100. The larger the value is, the clearer the edges are and vice versa. Note: The higher the value, the higher likelihood of picture noise occurring. The default value is 50 and the recommended value ranges from 40 to 60.

Gamma: This slider is used to adjust the gamma of the video. The larger the number, the brighter the video is. The default value is 50 and the recommended value ranges from 40 to 60.

Mirror: This radio button allows the user to turn the mirroring feature on or off. Turning mirroring on will mirror the picture.

Flip: This dropdown box allows the user to flip the video feed picture. Flipping the picture is recommended only if the camera is mounted upside down.

To reset to default settings, click the **Reset Defaults** button. To refresh the screen, click on Refresh. To save the settings, click the **Save** button.

Exposure

This menu allows the user to adjust exposure settings. Below is an explanation of the features listed in this menu.

Profile: This dropdown box allows the user to select which profile to modify. The 3 options are Day, Night, and General.

Anti-Flicker: These options allow the user to select what type of anti-flicker technology will be used for the video feed. The three options are 50 Hz, 60 Hz, and Outdoor. The desired option should offset any flickering effect caused by the electrical current used in the specific area.

Mode: This dropdown menu allows the user to modify certain exposure settings related to the device such as, gain priority, shutter priority or setting a manual gain setting.

Auto: This setting allows the camera to automatically adjust exposure settings while in use.

gain First: This setting will maximize the gain for the ideal exposure. Low Noise Basically turns up the ISO to the best setting without sacrificing exposure timing.

Shutter Priority: This setting will maximize the fastest shutter speed and will sacrifice the gain in return.

Manual - This setting lets you select your shutter speed and have the gain adjust automatically. Selecting customized range will let you both the shutter speed and adjust the gain manually.

3D NR: Allows the user to enable or disable 3D noise reduction.

3D NR Level: This slider allows the user to specify the 3D Noise Reduction level. The value ranges from 1-100.

To reset to default settings, click the **Reset Defaults** button. To refresh the screen, click on **Refresh**. To save the settings, click the **Save** button.

BLC Mode

This menu allows the user to adjust back light compensation settings. Below is an explanation of the features provided in this menu.

Profile: This dropdown box allows the user to select which profile to modify. The 3 options are Day, Night, and General.

OFF: Disables BLC mode.

BLC: backlight compensation: Default will use the whole image to balance the lighting settings, and Customized will allow you to balance the lighting settings from the target area.

HLC: Highlight compensation is a feature that came out of necessity due to overexposure from strong light sources like headlights or spotlights.

WDR: Wide Dynamic Range makes multiple scans of a scene to provide one balanced and unwashed image that is clear for the user.

To reset to default settings, click the **Reset Defaults** button. To refresh the screen, click on **Refresh**. To save the settings, click the **Save** button.

WB

This menu allows the user to adjust white balance settings. Below is an explanation of the features provided in this menu.

Profile: This dropdown box allows the user to select which profile to modify. The 3 options are Day, Night, and General.

Mode: This option allows the user to choose between different white balance modes.

Auto: Allows the camera to automatically adjust white balance settings while in use.

Sunny: Allows the camera to automatically adjust white balance settings in sunny or bright conditions.

Night: Allows the camera to automatically adjust white balance settings in nighttime or dark conditions.

Outdoor: Allows the camera to automatically adjust white balance settings while in outdoor (sunny or dark environments).

Customized: Displays options that will allow the user to manually adjust specific red or blue values related to white balance.

Regional Custom: Allows the user to select an area (region) on the live view screen in which white balance will be most applicable.

To reset to default settings, click the **Reset Defaults** button. To refresh the screen, click on Refresh. To save the settings, click the **Save** button.

Day & Night

This menu allows the user to adjust day and nighttime settings. Below is an explanation of the features provided in this menu.

Profile: This dropdown box allows the user to select which profile to modify. The 3 options are Day, Night, and General.

Mode: This dropdown box allows the user to select different Day & Night balance modes. The 3 options are Auto, Color, and B&W.

Color - Preset which allows the camera to compensate color in day or night profiles.

B&W - Sets the picture to black and white, however when illumination is too dark it switches on IR mode.

Auto - Uses D&N Sensitivity setting to change between color mode and infrared and black and white mode.

Sensitivity: This option allows the user to change the Day/Night Sensitivity of the camera. The three options are Low, Middle, and High. The higher the sensitivity, the quicker the camera will change into another mode depending on the light levels.

Delay: This dropdown box allows the user to set a delay in seconds for how long it takes to switch between Day and Night modes. The values range from 2 seconds to 10 seconds.

To reset to default settings, click the **Reset Defaults** button. To refresh the screen, click on Refresh. To save the settings, click the **Save** button.

IR Light

This menu allows the user to set IR light settings. The IR light on your camera allows the device the ability to activate night vision. Below is an explanation of the features provided in this menu.

Profile: This dropdown box allows the user to select which profile to modify. The 3 options are Day, Night, and Normal.

Mode: This dropdown box allows the user to select whether to turn the IR light on or off. Auto can also be set to automatically set the camera's IR lights on and off based on Day & Night conditions. This setting is usually set by default within the camera.

To reset to default settings, click the **Reset Defaults** button. To refresh the screen, click on Refresh. To save the settings, click the **Save** button.

Profile Management

Below is a screenshot that shows the Profile Management tab in the Configuration menu item:

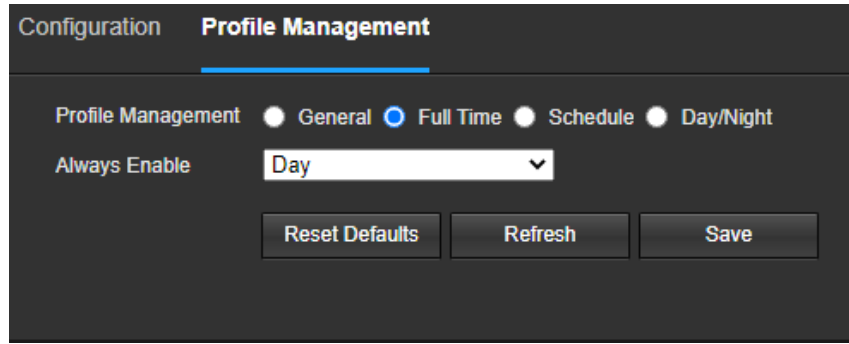

Below is an explanation for each of the fields on the Profile Management tab in the Configuration menu item:

Profile Management: This set of radio buttons allow the user to set what basis the profile management settings run on. There are 4 options: General, Full Time, Schedule, and Day/Night. General means that the system can automatically alternate between night and day based on the profiles for each.

Full Time means that the system sticks to one profile the entire time it is running. Schedule allows the user to dictate which times of the day are designated for the day profile and the night profile. Day/Night means that the system maintains one profile (Day or Night) for each mode set by the user.

To reset to default settings, click the **Reset Defaults** button. To refresh the screen, click on Refresh. To save the settings, click the **Save** button.

Video

This section allows the user to change video settings for the camera's video feed. There are 4 tabs in this menu item: Video, Snapshot, Overlay, and Path.

Video

Below is a screenshot that shows the Video tab in the Video menu item:

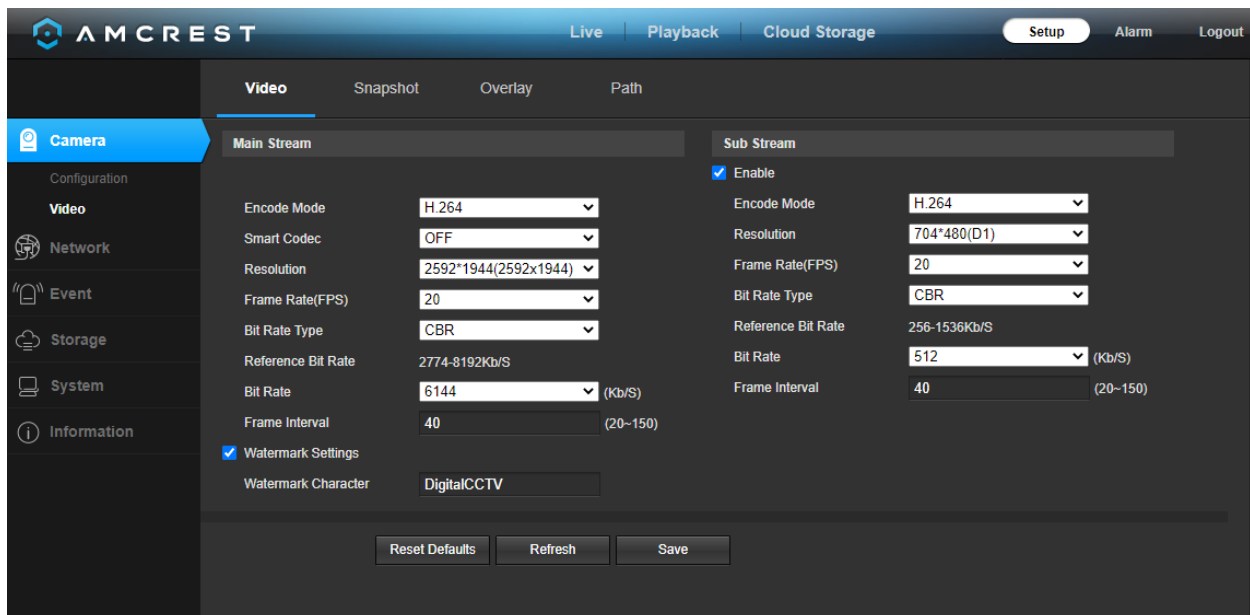

Below is an explanation for each of the fields on the Video tab in the Video menu item:

Encode Mode: This dropdown box allows the user to select a compression protocol.

Smart Codec: This option allows the user to enable or disable the smart codec. Smart codec is a function in most Amcrest cameras which aim to reduce bandwidth consumption without losing visible image quality by intelligently increasing compression where it will not make a visible difference in the scene.

Resolution: This dropdown box allows the user to set the resolution. The system supports various resolutions, and they can be selected from this dropdown list.

Frame Rate (FPS): This dropdown box allows the user to select a frame rate. Frame rate settings are measured in frames per second (FPS) and can range from 1f/s to 25f/s in PAL mode and 1f/s to 30f/s in NTSC mode.

Bit Rate Type: This dropdown box allows the user to select a bit rate type. The system supports two-bit rate types: CBR and VBR. In VBR mode, video quality can be set.

Reference Bit Rate: This is the recommended bit rate value according to the resolution and frame rate selected.

Bit Rate: This dropdown box allows the user to select a bit rate.

Frame Interval: This field allows the user to set the P frame amount between two I frames. The value ranges from 1 to 150 seconds. Default value is 50. Recommended value is frame rate * 2.

Watermark Settings: This function allows the user to verify if the video has been tampered with.

Watermark Character: This field allows the user to set the watermark's text. The default string is Digital CCTV. The maximum length is 85 characters. This string can only include numbers, characters, and underscores.

Sub Stream is a lower quality stream that allows the feed to take up less resources and bandwidth when streaming. The Mainstream and the Sub Stream have the same fields. Sub Stream can be enabled by checking the box next to Enable.

To reset to default settings, click the **Reset Defaults** button. To refresh the screen, click on Refresh. To save the settings, click the **Save** button.

Snapshot

Below is a screenshot that shows the Snapshot tab in the Video menu item:

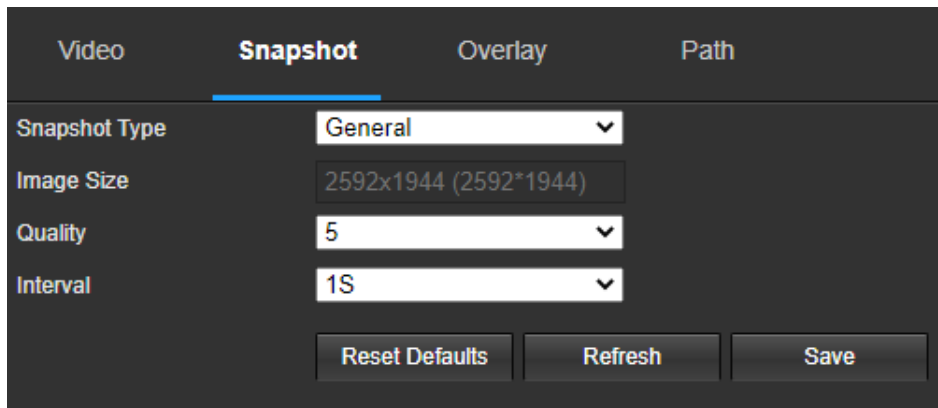

Video	Snapshot	Overlay	Path
Snapshot Type	General		
Image Size	2592x1944 (2592*1944)		
Quality	5		
Interval	1S		
Reset Defaults Refresh Save			

Below is an explanation for each of the fields on the Snapshot tab in the Video menu item:

- **Snapshot Type:** This dropdown box allows the user to select a snapshot mode. There are two snapshot modes:
 - General:** Snapshots are taken as scheduled.
 - Event:** Snapshots occur when a motion detection alarm or tampering alarm is triggered

- **Image Size:** This dropdown box shows the image size. By default, the screenshot size is the same size as the video feed's resolution.
- **Quality:** This dropdown box allows the user to select image quality. Quality is adjusted on a scale of 1-6 (Best).
- **Interval:** This is to set snapshot frequency. The value ranges from 1 to 7 seconds. The maximum setting for a customized interval is 3600s/picture.

To reset to default settings, click the **Reset Defaults** button. To refresh the screen, click on Refresh. To save the settings, click the **Save** button.

Overlay

Below is a screenshot that shows the Overlay tab in the Video menu item:

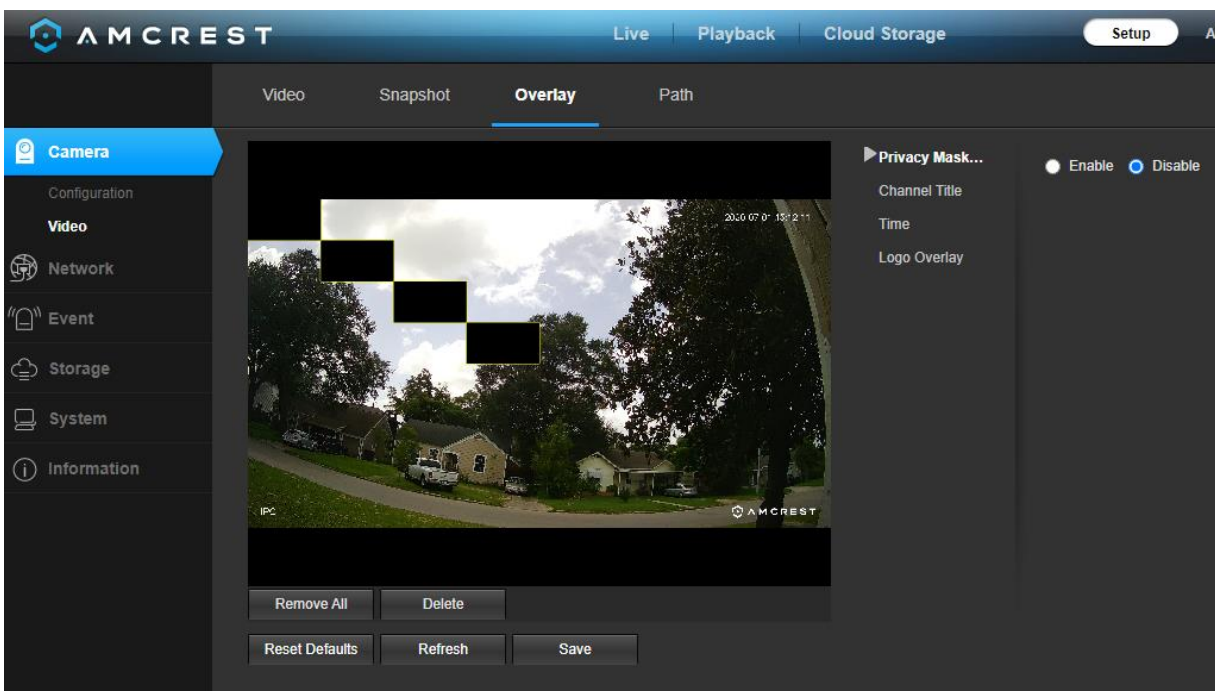

The menu on the left allows the user to select which overlay to modify. Privacy Masking, Channel Title, Time, and Text Overlay can all be modified in this menu.

For **Privacy Masking**, the radio button enables or disables the feature. To set a privacy mask, click one of the boxes in the live view window, and position or resize it as needed. To remove a box, click on it, then click the delete button. To remove all privacy filter boxes, click the remove all button.

For **Channel Title**, the radio button enables or disables the feature. The Input Channel Title field allows the channel title to be modified.

For **Time**, the radio button enables or disables the feature. Clicking the Display Weekdays checkbox will show the weekday at the end of the timestamp.

For **Logo Overlay**, the radio button enables or disabled the Amcrest logo from the live view screen.

To remove all the settings applied in this menu, click **Remove All**. To delete a specific setting, select the setting you wish to delete can click **Delete**. To reset to default settings, click the **Reset Defaults** button. To refresh the screen, click on Refresh. To save the settings, click the **Save** button.

Network

This menu section allows the user to change network settings for the camera.

TCP/IP

The TCP/IP menu item has two tabs: TCP/IP and P2P.

TCP/IP

TCP/IP stands for Transmission Control Protocol/Internet Protocol and it is the language/protocol that allows communication between internet connected devices, whether on a local network, or a on the Internet at large. This screen allows for TCP/IP settings to be modified for the camera to establish a connection to the network.

Below is a screenshot of the TCP/IP settings tab:

The screenshot displays the TCP/IP configuration interface. At the top, there are two tabs: 'TCP/IP' (selected) and 'P2P'. The settings are as follows:

Host Name	IPC
Ethernet Card	Wire(Default)
Mode	<input checked="" type="radio"/> Static <input type="radio"/> DHCP
MAC Address	9c . 8e . cd . 2b . 41 . 74
IP Version	IPv4
IP Address	10 . 0 . 0 . 66
Subnet Mask	255 . 255 . 255 . 0
Default Gateway	10 . 0 . 0 . 1
Preferred DNS	75 . 75 . 75 . 75
Alternate DNS Server	75 . 75 . 76 . 76

Enable ARP/Ping to set IP address service

Buttons: Reset Defaults, Refresh, Save

Below is an explanation of the fields on the TCP/IP settings tab:

Host Name: This text field allows the user to change the host device name for the camera. This field supports a maximum of 15 characters.

Ethernet Card: This dropdown box allows the user to select which internet access device to use. If the device is connected to a wired connection and a wireless one at the same time, then this box will have options to pick either of the connections. The Set as Default button allows the user to select one of the connection methods as the default one.

Mode: Static vs DHCP: This radio button allows the user to choose between a static IP address, and a dynamic IP address. DHCP stands for Dynamic Host Configuration Protocol, and this enables the camera to automatically obtain an IP address from another network device such as a server or more commonly, a router. When the DHCP function is enabled, the user cannot modify the IP address, Subnet Mask, or Default Gateway, as these values are obtained from the DHCP function. To view the current IP address, DHCP needs to be disabled. Note: When PPPoE is enabled, modification of the IP Address, Subnet Mask, and Gateway becomes prohibited.

MAC Address: This field shows the camera's MAC address, which is unique to this device. This number is read only and is used to access a local area network (LAN).

IP Version: This dropdown allows the user to select the IP version. The two options are IPV4 and IPV6.

IP Address: This field allows the user to enter a custom IP address.

Subnet Mask: This field allows the user to enter a custom subnet mask.

Default Gateway: This field allows the user to enter a custom default gateway.

Preferred DNS Server: This field allows the user to enter the preferred DNS server IP address.

Alternate DNS Server: This field allows the user to enter the alternate DNS server IP address.

Enable ARP/Ping to set IP Address Service: This checkbox allows the user to enable the ARP/Ping service to change the IP address service. For more information on this feature, click the help button while on the TCP/IP settings tab.

To reset to default settings, click the **Reset Defaults** button. To refresh the page, click the **Refresh** button. To save the settings, click the **Save** button.

P2P

The P2P settings screen is where users can use a QR code to connect their smartphone or tablet to the camera. This feature needs to be enabled for use with the Amcrest View app, Amcrest Cloud, or AmcrestView.com.

Below is a screenshot of the P2P settings tab:

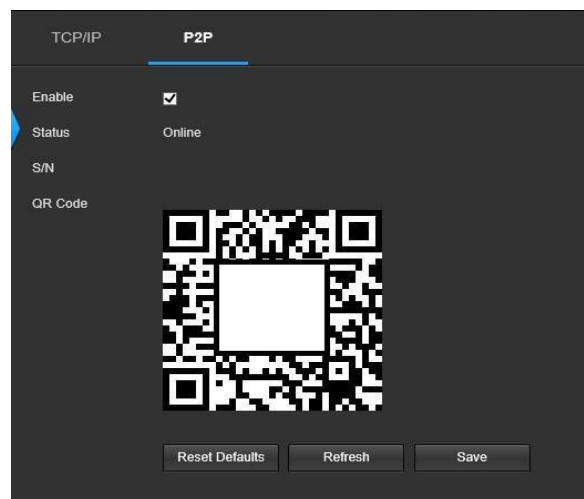

Below is an explanation of the fields on the P2P settings tab:

Enable: This checkbox allows the user to enable the P2P feature for the camera. This feature must be enabled for the camera to connect to a smartphone or tablet via the Amcrest View app. It is enabled by default.

Status: This field displays the status of the P2P connection. Once the camera is connected to a device, this field should display the word Online.

S/N: This field displays the Token ID for the camera. The Token ID can be used to manually enter the camera's information on a mobile or tablet device in case the QR code scanning feature cannot be used.

QR Code: This image is a Quick Response (QR) code. By scanning this image using the Amcrest View app, this camera can establish a connection with the app.

To reset to default settings, click the **Reset Defaults** button. To refresh the page, click the **Refresh** button. To save the settings, click the **Save** button.

Connection

The **Connection** tab is where users can configure port connections.

Below is a screenshot of the Port settings tab:

Field	Value	Range
Max Connections	10	(1~20)
TCP Port	37777	(1025~65534)
UDP Port	37778	(1025~65534)
HTTP Port	80	
RTSP Port	554	
HTTPS Port	443	

Buttons: Reset Defaults, Refresh, Save

Below is an explanation of the fields on the Connection settings tab:

Max Connections: This field allows the user to specify the maximum number of users that can be connected to the camera at the same time. The maximum number of users the camera can support at one time is 20.

TCP Port: This field designates the Transmission Control Protocol (TCP) port number. The default value is 37777.

UDP Port: This field designates the User Datagram Protocol (UDP) port number. The default value is 37778.

HTTP Port: This field designates the Hypertext Transfer Protocol (HTTP) port number. The default value is 80.

RTSP Port: This field designates the Real Time Streaming Protocol (RTSP) port number. The default value is 554.

HTTPS: This field enables the use of the HTTPS protocol for accessing the camera.

HTTPS Port: This field designates the Hypertext Transfer Protocol Secure (HTTPS) port number. The default value is 443.

To reset to default settings, click the **Reset Defaults** button. To refresh the page, click the **Refresh** button. To save the settings, click the **Save** button.

ONVIF

The ONVIF tab is where users can configure authentication via the ONVIF standard. Below is a screenshot of the ONVIF settings tab:

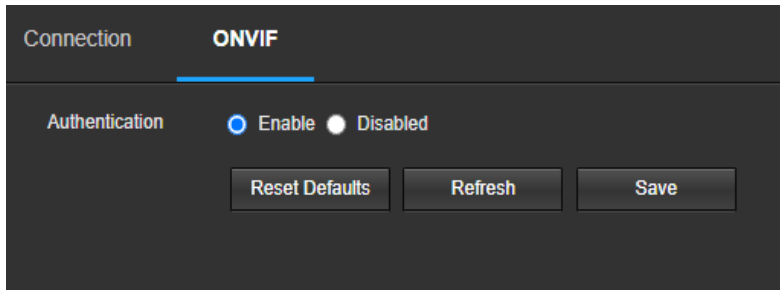

To enable ONVIF, click the radio button next to Enable, and then click the save button.

To reset to default settings, click the **Reset Defaults** button. To refresh the page, click the **Refresh** button. To save the settings, click the **Save** button.

DDNS

DDNS stands for Dynamic Domain Name Server. This technology is used to automatically update name servers in real time to help the camera maintain a persistent address despite changes in location or configuration. What this means is that even when the camera is restarted, moved, or reconfigured, it can keep the same IP address, thus allowing remote users uninterrupted access to the camera, rather than having to request a new IP address to use for remote access anytime a change is made.

To use this feature, users will need to setup an account with a DDNS service. The camera supports a variety of DDNS services such as AMCRESTDDNS, NO-IP DDNS, CN99 DDNS, and DynDNS DDNS. Based on which service is selected, different options may show on this screen. For purposes of this guide, AmcrestDDNS will be used. AmcrestDDNS is a free DDNS service provided by Amcrest, and it must be renewed every year. A renewal reminder email will be sent to the email entered in the username field below.

Below is a screenshot of the DDNS settings screen, configured to AmcrestDDNS:

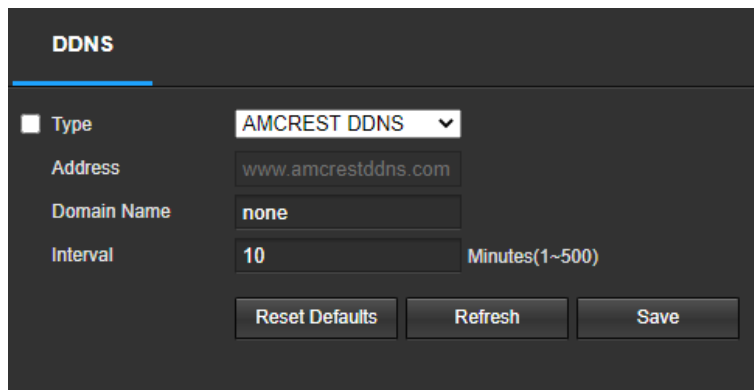

To reset to default settings, click the **Reset Defaults** button. To refresh the page, click the **Refresh** button. To save the settings, click the **Save** button.

IP Filter

This screen allows for the filtering of IP addresses, either blocking them, or granting them access to the camera. This feature helps make the camera more secure by limiting remote access only to approved users. Below is a screenshot of the IP Filter screen:

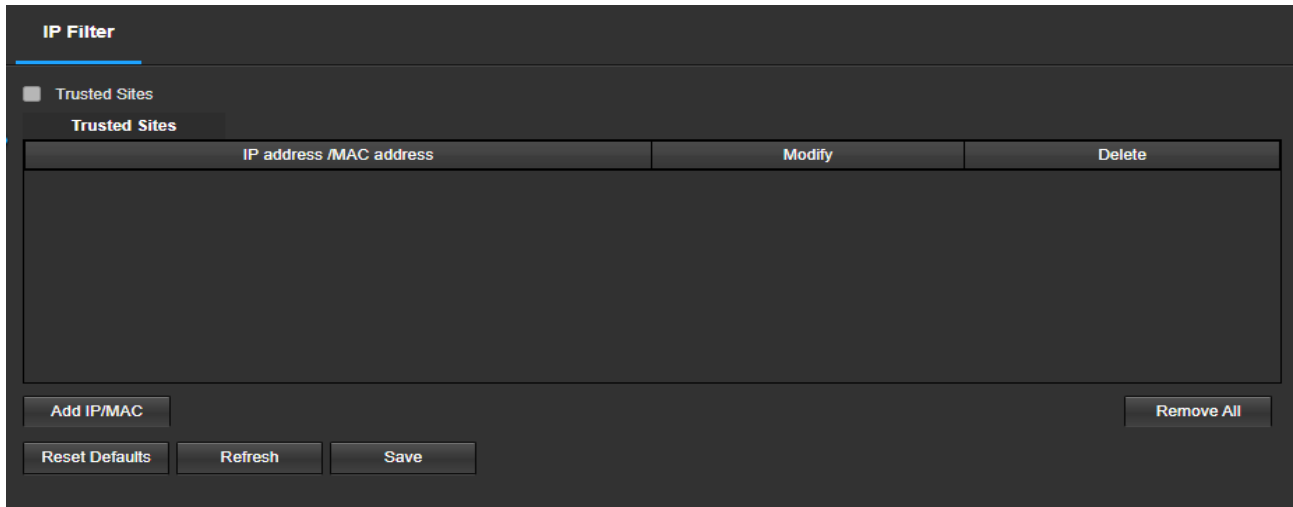

Below is an explanation of fields on the IP Filter settings screen:

Trusted Sites: This checkbox allows the user to enable the IP Filter feature for trusted sites.

Add IP/MAC: This button opens a popup that allows the user to add IP or MAC addresses to the trusted site list.

Note: When accessing the camera externally, please add the MAC address of the router on the PC end.

Remove All: This button allows the user to remove all sites from the trusted IP/MAC list.

To reset to default settings, click the Reset Defaults button. To refresh the page, click the Refresh button. To save the settings, click the Save button.

SMTP (Email)

This screen allows for the configuring of email settings to permit the camera to send emails when an alarm is triggered. Below is a screenshot of the email settings screen:

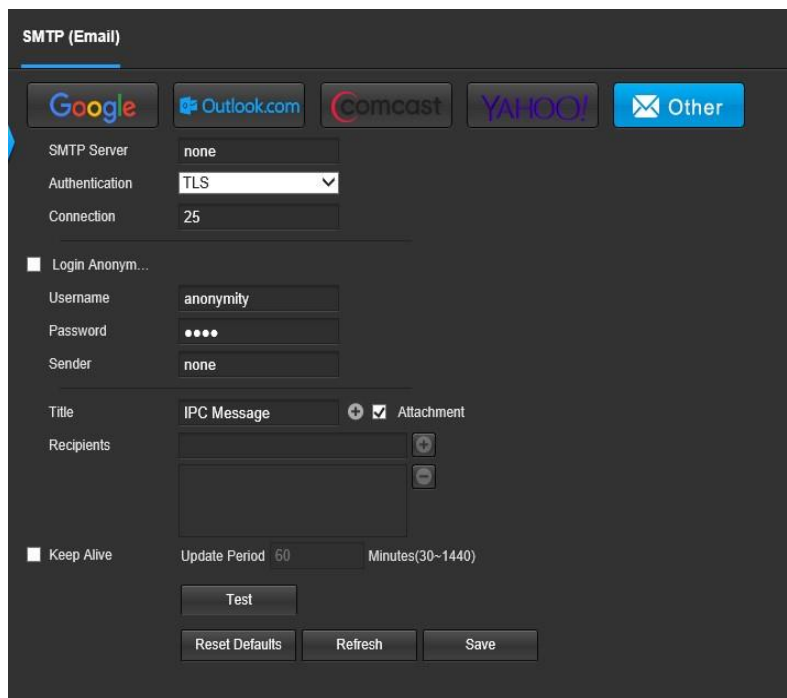

Below is an explanation of fields on the SMTP (Email) settings screen:

SMTP Server: SMTP stands for Simple Mail Transfer Protocol. This field allows the user to enter the SMTP server used by the email service.

Port: This field allows the user to enter the port that corresponds to the selected SMTP server.

Login Anonymously: This checkbox allows the user to anonymously login to the server.

Username: This field allows the user to enter the SMTP username.

Password: This field allows the user to enter the password associated with the SMTP username.

Sender: This field allows the user to enter the sender email address. This email address will be the one that sends out all emails pertaining to the alerts and alarm emails sent by the camera.

Authentication: This dropdown box allows the user to select an encryption type. There are two types of email encryption protocols that are available.

SSL: Secure Socket Layer

TLS: Transport Layer Security

Subject: This field allows the user to define the subject line of the email that is sent to the receivers.

Recipients: This field allows the user to enter the receiver email address. These email addresses are the ones that will receive any emails pertaining to alert and alarm emails sent by the camera. Up to 3 email addresses can be entered in this field.

Interval: This field allows the user to define, in seconds, how long the system should wait between sending emails. This prevents multiple emails from being sent out.

Keep Alive: This checkbox allows the user to enable a function to periodically check in with the SMTP server to ensure it can connect correctly.

Email Test: This button causes the system to automatically send out an email to test the connection is OK or not. Prior to the email test, please save the email setup information.

To reset to default settings, click the **Reset Defaults** button. To refresh the page, click the **Refresh** button. To save the settings, click the **Save** button.

UPnP

UPnP stands for Universal Plug and Play, and it is a protocol used to easily connect devices to the internet. In the case of this camera, it allows the camera to connect to the router in an easy manner to quickly allow for remote access. Below is a screenshot of the UPnP settings screen:

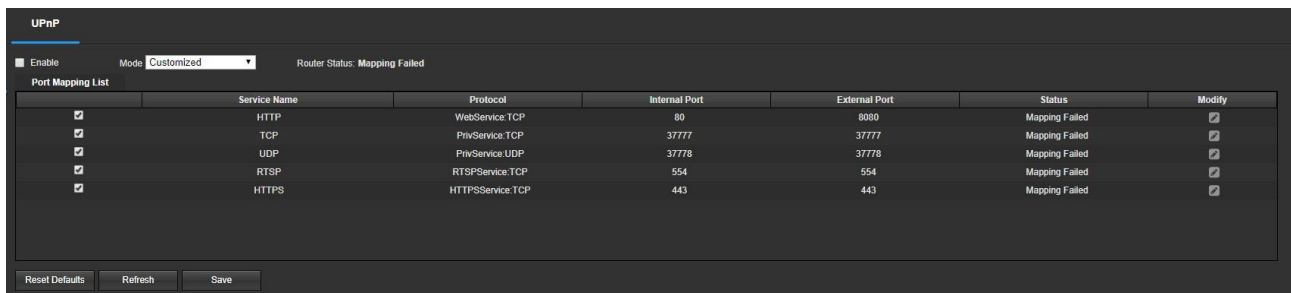

The screenshot shows the UPnP settings interface. At the top, there is a title 'UPnP', an 'Enable' checkbox, a 'Mode' dropdown set to 'Customized', and a 'Router Status: Mapping Failed' indicator. Below this is a 'Port Mapping List' table with columns for checkboxes, Service Name, Protocol, Internal Port, External Port, Status, and Modify. At the bottom, there are three buttons: 'Reset Defaults', 'Refresh', and 'Save'.

	Service Name	Protocol	Internal Port	External Port	Status	Modify
<input checked="" type="checkbox"/>	HTTP	WebService:TCP	80	8080	Mapping Failed	
<input checked="" type="checkbox"/>	TCP	PrivService:TCP	37777	37777	Mapping Failed	
<input checked="" type="checkbox"/>	UDP	PrivService:UDP	37778	37778	Mapping Failed	
<input checked="" type="checkbox"/>	RTSP	RTSPService:TCP	554	554	Mapping Failed	
<input checked="" type="checkbox"/>	HTTPS	HTTPSService:TCP	443	443	Mapping Failed	

Below is an explanation of fields on the UPnP settings screen:

Enable: This checkbox allows the user to enable the UPnP function.

Router State: This field shows the UPnP status and has two options: **Unknown:** This means that UPnP mapping has failed. **Successful:** This means that UPnP mapping has succeeded.

Port Mapping List: This table is used to show how the ports for each protocol listed below have been remapped by the UPnP protocol.

The first column shows the checkboxes to enable the corresponding service on the table.

The second column shows the name of the services. To edit this, double click on the service line item.

The third column shows the name of the protocol used by that service. To edit this, click the pencil button in the modify column for that line item.

The fourth column shows the Internal Port used by that service to establish communication from the router to the camera. To edit this, click the pencil button in the modify column for that line item. ○ The fifth column shows the External Port used by that service to establish communication from the router to the internet. To edit this, click the pencil button in the modify column for that line item.

The sixth column shows the status of the protocol. If the protocol was mapped successfully, this field will say "Mapping Succeeded".

The seventh column allows the user to open a dialog box and edit the service's information.

To reset to default settings, click the **Reset Defaults** button. To refresh the page, click the **Refresh** button. To save the settings, click the **Save** button.

HTTPS

This menu allows the user to enable and create HTTPS certificates. Below is a screenshot of this menu:

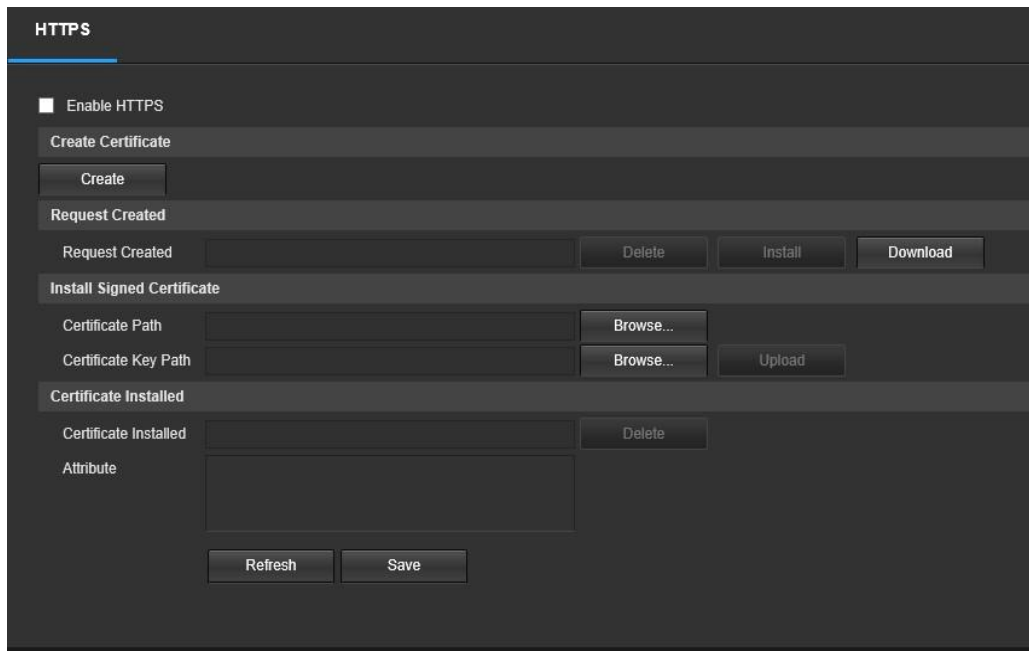

The screenshot shows a web interface for configuring HTTPS. At the top, there is a section titled "HTTPS" with a sub-section "Enable HTTPS" containing a checkbox. Below this is a "Create Certificate" section with a "Create" button. The next section is "Request Created", which displays a table with columns for "Request Created", "Delete", "Install", and "Download". The "Install Signed Certificate" section includes input fields for "Certificate Path" and "Certificate Key Path", each with a "Browse..." button, and an "Upload" button. The "Certificate Installed" section shows a table with columns for "Certificate Installed" and "Delete", and an "Attribute" field. At the bottom, there are "Refresh" and "Save" buttons.

Before you create certificate or download certificate, from main window->Setup->Network->Connection, set the HTTPS port values and then check the box to enable HTTPS.

For more information on how to setup HTTPS in the web user interface visit

<https://www.youtube.com/watch?v=gkjlaf-luso>

Event

This menu section allows the user to change different settings for triggering events.

Video Detection

The video detection menu has two tabs: Motion Detect and Video Tamper.

Motion Detect

This tab allows the user to modify motion detection settings. Below is a screenshot of the Motion Detect tab:

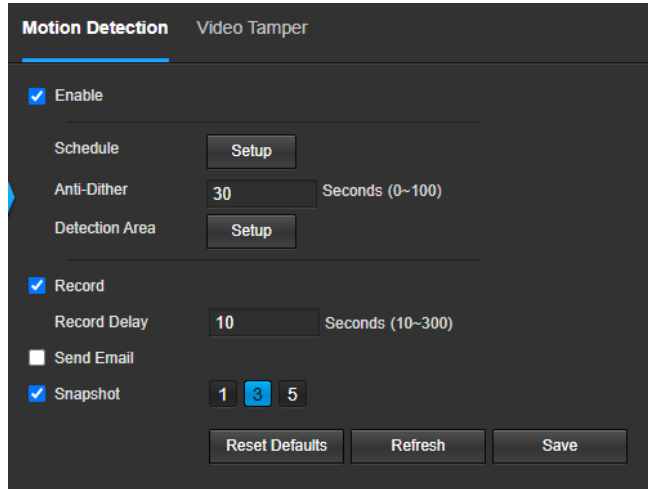

Below is an explanation of the fields on the Motion Detect tab:

Enable: This checkbox enables motion detection for the camera.

Schedule: Clicking this button opens a weekly schedule that can be used to set times.



Click and drag to set motion detection for certain days of the week. Also, periods of motion detection can be set for each day and enabled using the period settings on the bottom half of the screen. There are a total of 6 periods that can be set.

Anti-Dither: This field allows the user to set the anti-dither time. The values in this field can range from 5 to 600 seconds. This time value controls how long the alarm signal lasts. Based on motion detection, a buzzer can go off, a tour can begin, a snapshot can be taken, or the camera can begin recording.

For example, if the anti-dither time is set to 10 seconds, each alarm may last 10 seconds if the local alarm is activated. During the process, if the system detects another local alarm signal at the fifth second, the buzzer, tour, snapshot, record channel functions will begin another 10 seconds while the screen prompt, alarm upload, email will not be activated again. After 10 seconds, if system detects another alarm signal, it can generate a new alarm since the anti-dither time has expired.

Detection Area: Clicking this button opens a pop-up screen that can be used to set detection areas.

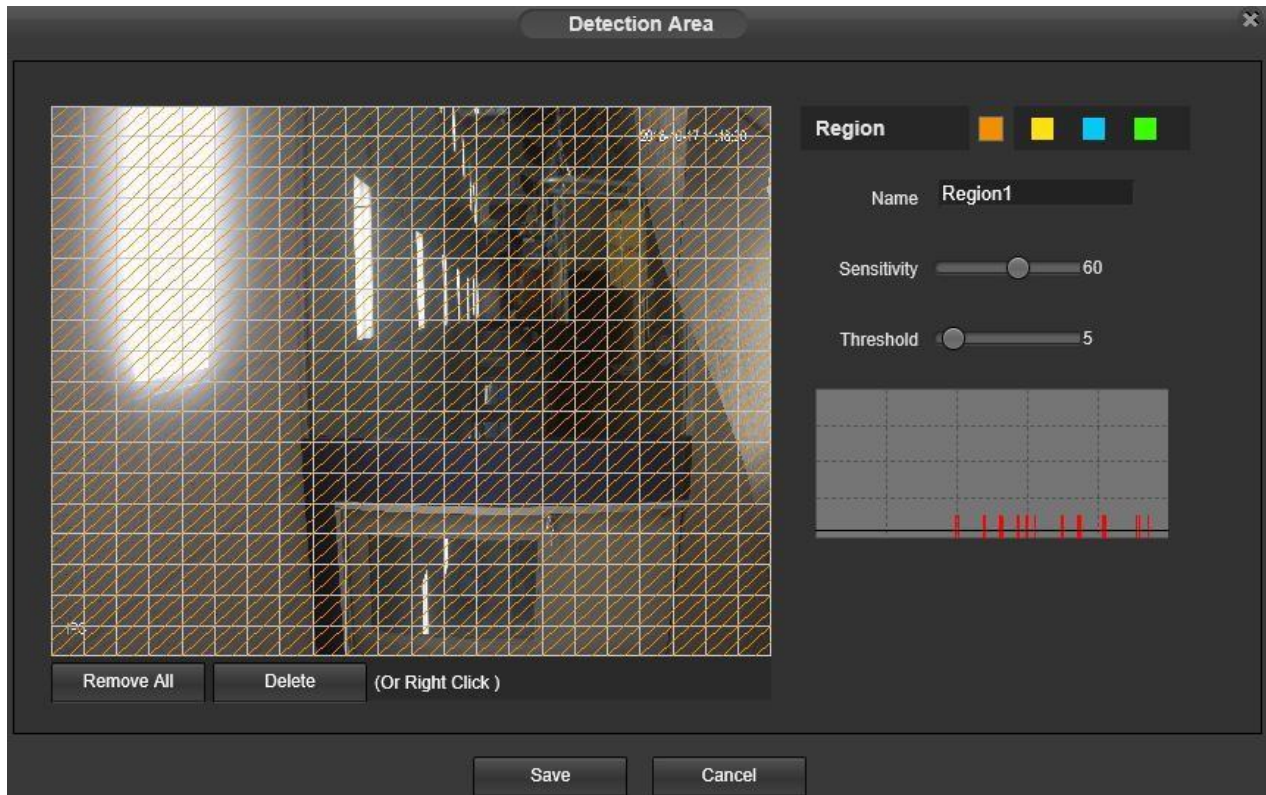

When the setup button is clicked, a live stream of the video is shown. The user can then set up to 4 regions, each with their own region name, sensitivity (1-100), and threshold (1-100). Each region has a specific color, and the region selector tool is displayed when the mouse is moved to the top of the screen.

Sensitivity is the amount of change required to increase the motion detected by a percentage. The lower the sensitivity, the more movement is required to trigger an alarm.

Threshold is the level that the motion detection needs to reach to trigger an alarm. The lower the threshold, the more likely that motion will trigger an alarm.

To designate a zone, click and drag the mouse over the area desired. When a colored box is displayed over the live feed, that area is now enabled for motion detection.

After the motion detection zone is set, click the enter button to exit the motion detection screen.

Remember to click the save button on the motion detection settings screen, otherwise the motion detection zones will not go into effect. Clicking the cancel button to leave the motion detection zone and will not save the zone setup.

Record: This checkbox allows the user to enable the camera to record video when a motion detection alarm is triggered.

Record Delay: This field specifies in seconds how long the delay between alarm activation and recording should be.

Relay Out: This checkbox allows the user to enable the camera to trigger a connected alarm (connected to the alarm port on the back of the camera) when a motion detection alarm is triggered.

Alarm Delay: This field specifies in seconds how long the delay between alarm activation and Relay alarm activation should be.

Send Email: This checkbox allows the user to enable the camera to send an email when a motion detection alarm is triggered.

Snapshot: This checkbox allows the user to enable the camera to take a snapshot when a motion detection alarm is triggered.

To reset to default settings, click the **Reset Defaults** button. To refresh the page, click the **Refresh** button. To save the settings, click the **Save** button.

Video Tamper

This tab allows the user to modify video tamper settings. Below is a screenshot of the Video Tamper tab:

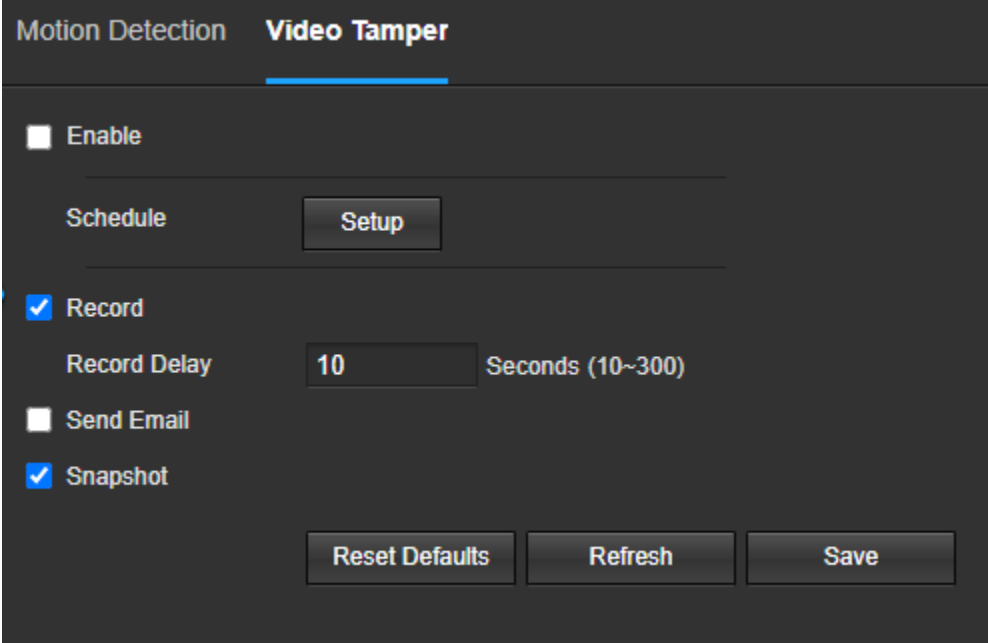

The screenshot shows a web interface with two tabs: "Motion Detection" and "Video Tamper". The "Video Tamper" tab is selected and highlighted with a blue underline. Below the tabs, there are several settings:

- An "Enable" checkbox, which is currently unchecked.
- A "Schedule" section with a "Setup" button.
- A "Record" checkbox, which is checked.
- A "Record Delay" field with a value of "10" and a unit of "Seconds (10~300)".
- A "Send Email" checkbox, which is unchecked.
- A "Snapshot" checkbox, which is checked.
- At the bottom, there are three buttons: "Reset Defaults", "Refresh", and "Save".

Below is an explanation of the fields on the Video Tamper tab:

Enable: This checkbox enables a video tamper alarm for the camera.

Schedule: Clicking this button opens a weekly schedule that can be used to set times.

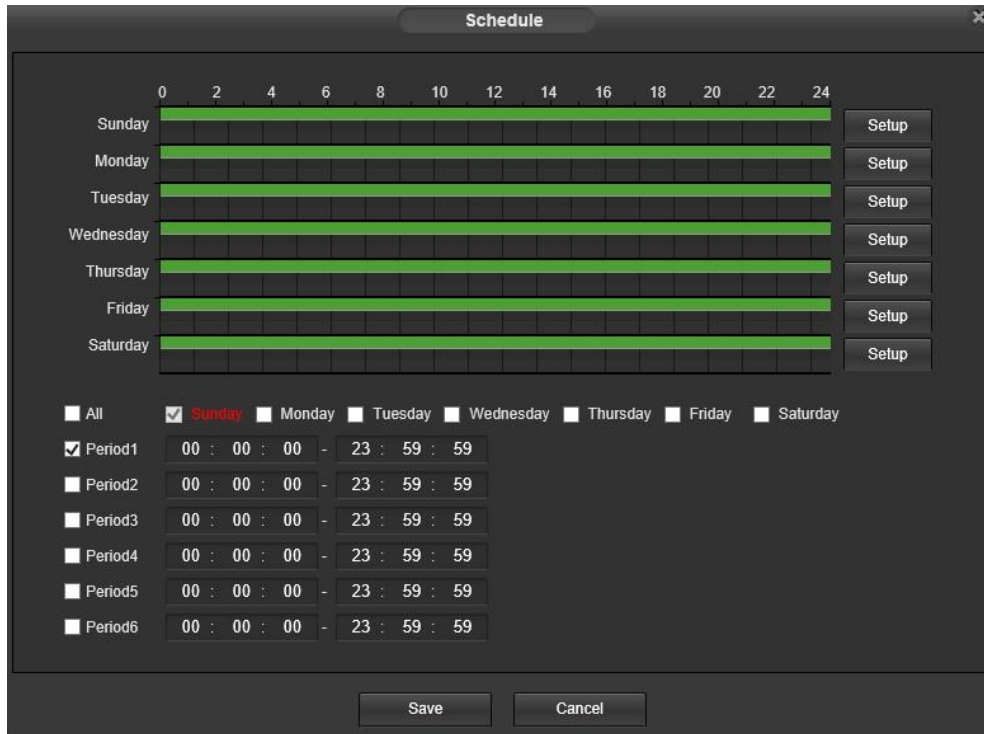

Click and drag to set video tampering for certain days of the week. Also, periods of video tampering can be set for each day and enabled using the period settings on the bottom half of the screen. There are a total of 6 periods that can be set.

Record: This checkbox allows the user to enable the camera to record video when a video tampering alarm is triggered.

Record Delay: This field specifies in seconds how long the delay between alarm activation and recording should be.

Relay Out: This checkbox allows the user to enable the camera to trigger a connected alarm (connected to the alarm port on the back of the camera) when a video tamper alarm is triggered.

Alarm Delay: This field specifies in seconds how long the delay between alarm activation and Relay alarm activation should be.

Send Email: This checkbox allows the user to enable the camera to send an email when a video tampering alarm is triggered.

Snapshot: This checkbox allows the user to enable the camera to take a snapshot when a video tampering alarm is triggered.

To reset to default settings, click the Reset Defaults button. To refresh the page, click the Refresh button. To save the settings, click the Save button.

Abnormality

This menu allows the user to adjust abnormality event settings. This menu has 3 tabs: SD Card, Network, and Illegal Access.

SD Card

This tab allows the user to set the camera's response to an SD card related abnormality. Below is a screenshot of the SD card tab screen:

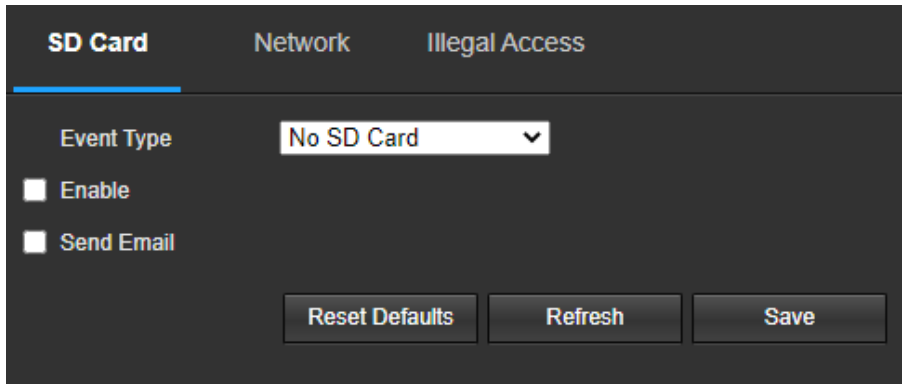

Below is an explanation of the fields on the SD Card settings tab:

Event Type: This dropdown box allows the user to select which SD card abnormality to set event triggers for. The 3 options are No SD Card, SD Card Error, and Capacity Warning.

Enable: This checkbox enables the SD Card abnormality trigger for the camera.

Send Email: This checkbox allows the user to enable the camera to send an email when an SD Card abnormality is detected.

To reset to default settings, click the **Reset Defaults** button. To refresh the page, click the **Refresh** button. To save the settings, click the **Save** button.

Network

This tab allows the user to set the camera's response to a Network related abnormality. Below is a screenshot of the Network tab screen:

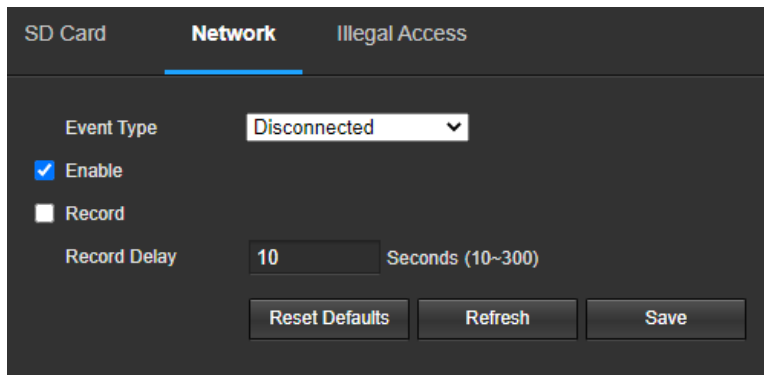

Below is an explanation of the fields on the Network settings tab:

Event Type: This dropdown box allows the user to select which Network abnormality to set event triggers for. The 2 options are Disconnection and IP Conflict.

Enable: This checkbox enables the Network abnormality trigger for the camera.

Record: This checkbox allows the user to enable the camera to record video when a network abnormality is detected.

Record Delay: This field specifies in seconds how long the delay between alarm activation and recording should be.

To reset to default settings, click the **Reset Defaults** button. To refresh the page, click the **Refresh** button. To save the settings, click the Save button.

Illegal Access

This tab allows the user to set the camera's response to an Illegal Access related abnormality. Below is a screenshot of the Illegal Access tab screen:

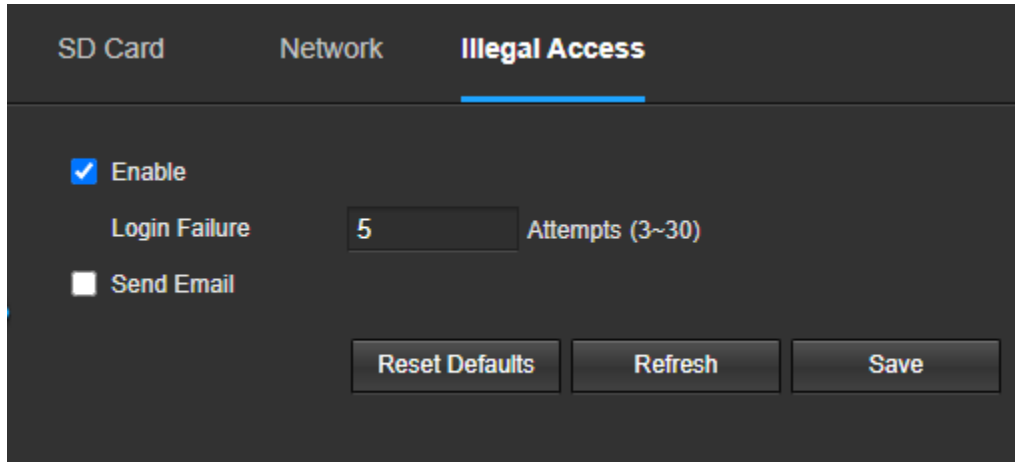

Below is an explanation of the fields on the Illegal Access settings tab:

Enable: This checkbox enables the Illegal Access abnormality trigger for the camera.

Login Failure: This field allows the user to specify how many failed login attempts must be attempted to trigger an Illegal Access abnormality event.

Send Email: This checkbox allows the user to enable the camera to send an email when illegal access is attempted.

To reset to default settings, click the **Reset Defaults** button. To refresh the page, click the **Refresh** button. To save the settings, click the **Save** button.

Storage

This menu section allows the user to change storage settings for the camera.

Schedule

The schedule menu manages the recording schedule for the camera. This menu has 3 tabs: Record Schedule, Snapshot Schedule, and Holiday Schedule.

Record Schedule

This tab is where video recording settings are configured. Below is a screenshot of the Record Schedule settings screen:

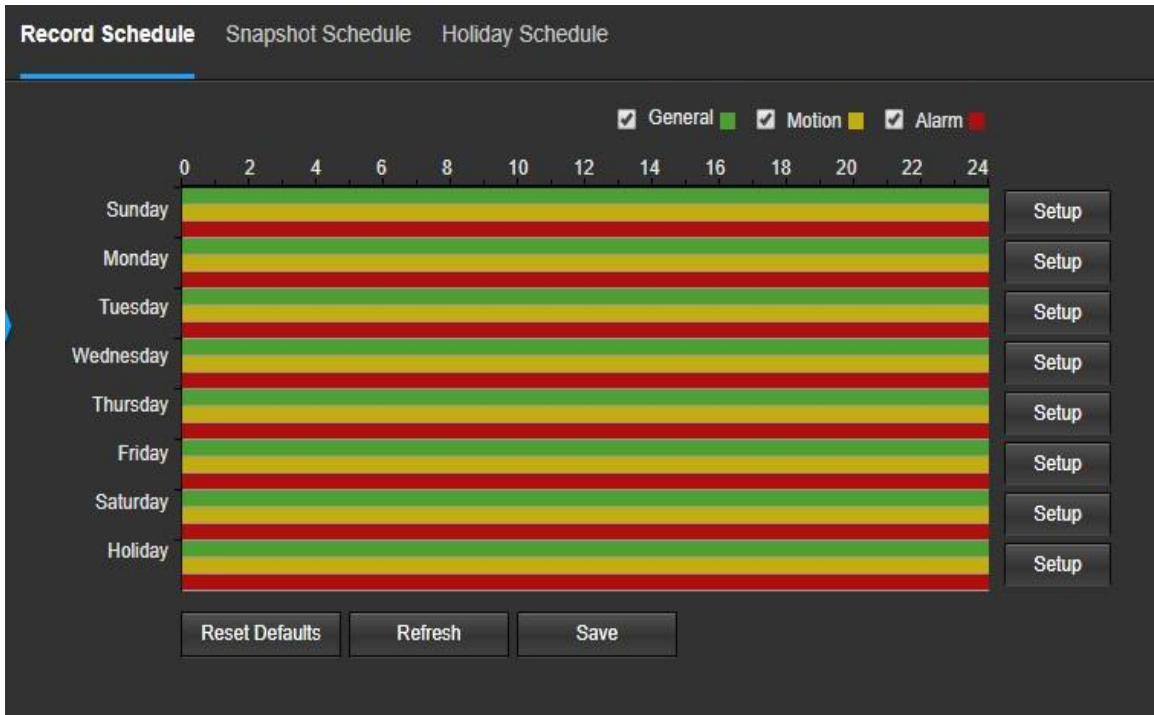

Below is an explanation of the fields on the Record Schedule settings tab:

Record Type: These checkboxes allow the user to select which recording type they want to configure on the schedule. There are 3 types of recordings:

General: General recording means that the camera captures all footage for the specified time period. General recording is represented by the color green.

Motion: Motion Detection recording means that the camera captures only footage when the motion detection alarm is activated. Motion recording is represented by the color yellow.

Alarm: Alarm recording means that the camera captures only footage when an alarm is activated. Alarm recording is represented by the color red.

Video Recording Schedule: To specify a video recording range, first select the type of recording desired, then click and drag on time bar for the desired date. To edit multiple days at once, drag the cursor further up or down to cover the other days.

Setup: Clicking this button opens a screen that allows for recording periods to be set for each day and for each recording type. There are a total of 6 periods that can be set.

To reset to default settings, click the **Reset Defaults** button. To refresh the page, click the **Refresh** button. To save the settings, click the **Save** button.

Snapshot Schedule

This tab is where snapshot recording settings are configured. Below is a screenshot of the Snapshot Schedule settings screen:

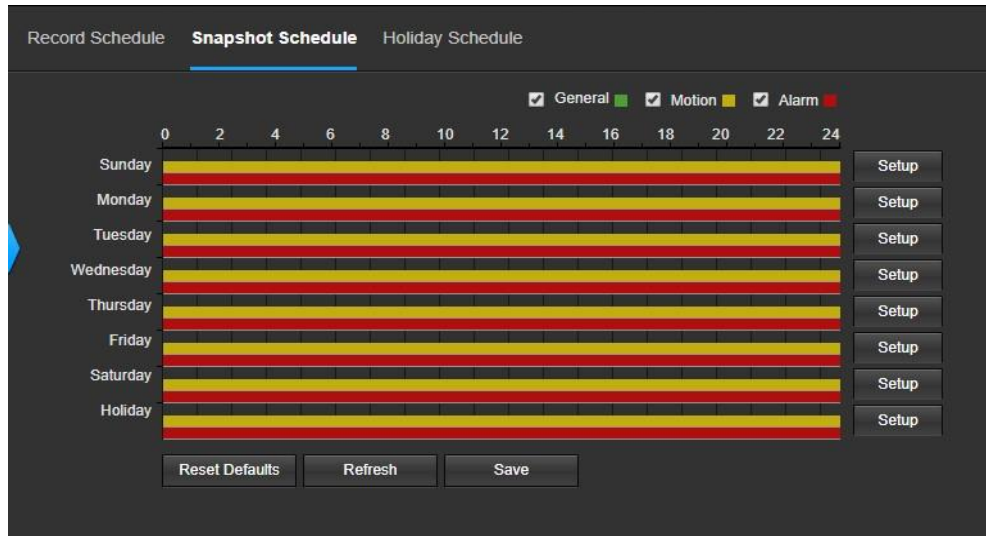

Below is an explanation of the fields on the Snapshot Schedule settings tab:

Record Type: These checkboxes allow the user to select which snapshot type they want to configure on the schedule. There are 3 types of snapshots:

General: General means that the camera will take snapshots during the specified time period. General recording is represented by the color green.

Motion: Motion Detection means that the camera only takes snapshots when the motion detection alarm is activated. Motion recording is represented by the color yellow.

Alarm: Alarm means that the camera only takes snapshots when an alarm is activated. Alarm recording is represented by the color red.

Snapshot Recording Schedule: To specify a snapshot range, first select the type of snapshot desired, then click and drag on time bar for the desired date. To edit multiple days at once, drag the cursor further up or down to cover the other days.

Setup: Clicking this button opens a screen that allows for snapshot periods to be set for each day and for each snapshot type. There are a total of 6 periods that can be set.

To reset to default settings, click the **Reset Defaults** button. To refresh the page, click the **Refresh** button. To save the settings, click the **Save** button.

Holiday Schedule

This tab is where holiday settings are configured. Below is a screenshot of the Holiday Schedule settings screen:

Below is an explanation of the fields on the Holiday Schedule settings tab:

Record Type: These checkboxes allow the user to select which recording type they want to configure on the schedule. There are 2 types of recordings:

Record: This checkbox is referring to video recording.

Snapshot: This checkbox is referring to snapshot recording.

Calendar: This calendar allows the user to select days to designate as holidays. Once a day is designated, it can be customized to stop recording or snapshots for that day by using the Record and Snapshot checkboxes.

To refresh the page, click the **Refresh** button. To save the settings, click the **Save** button.

Destination

This menu controls where recorded media is stored. There are 4 tabs in this menu: Path, SD Card, FTP, and NAS.

Path

This tab is where the user can designate a path for recorded video and snapshots to reside in. Below is a screenshot of the Path tab:

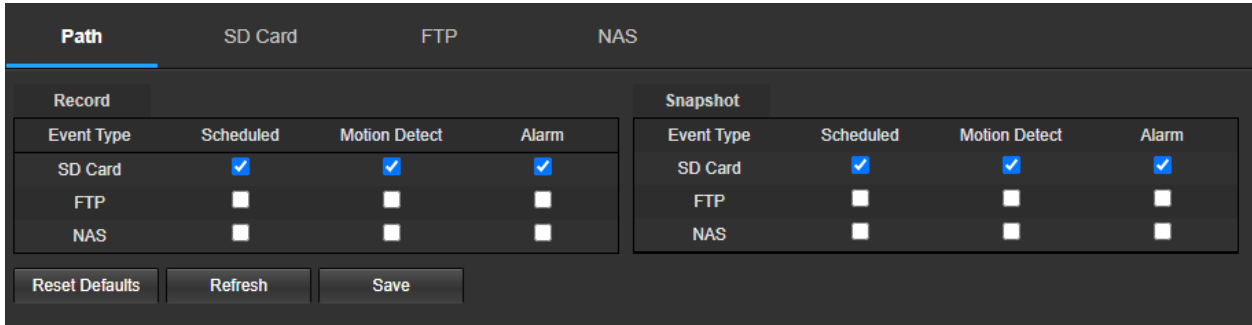

Below is an explanation of the fields on the Path settings tab:

Event Type: This column designates storage options available to the camera. The options are SD Card, FTP, and NAS.

Record Type: These columns designate which recording type should be recorded to which event type. Check the box at the intersection of the record type and event type to designate where that recording should be sent to.

To reset to default settings, click the **Reset Defaults** button. To refresh the page, click the **Refresh** button. To save the settings, click the **Save** button.

SD Card

This tab is where the user can change SD card settings. Below is a screenshot of the SD Card tab:

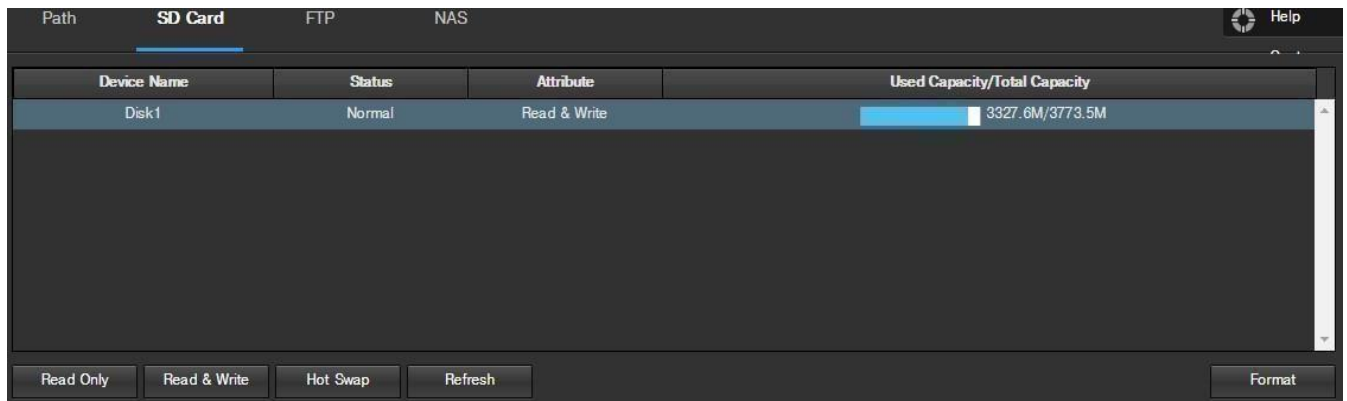

Below is an explanation of the fields on the SD Card settings tab:

Device Name: This column designates the name of the SD card that is currently in the camera.

Status: This column designates the status of the SD card.

Attribute: This column designates the read/write attributes for the SD card. By default, this is Read & Write.

Used Capacity/Total Capacity: This column shows the available memory on the SC card.

Read Only: This button allows the user to designate an SD card as read only.

Read & Write: This button allows the user to designate an SD card to read and & write privileges.

Refresh: This button refreshes the SD card table.

Format: This button formats the SD card.

To reset to default settings, click the **Reset Defaults** button. To refresh the page, click the **Refresh** button. To save the settings, click the **Save** button.

FTP

This tab is where the user can change FTP settings. Below is a screenshot of the FTP tab:

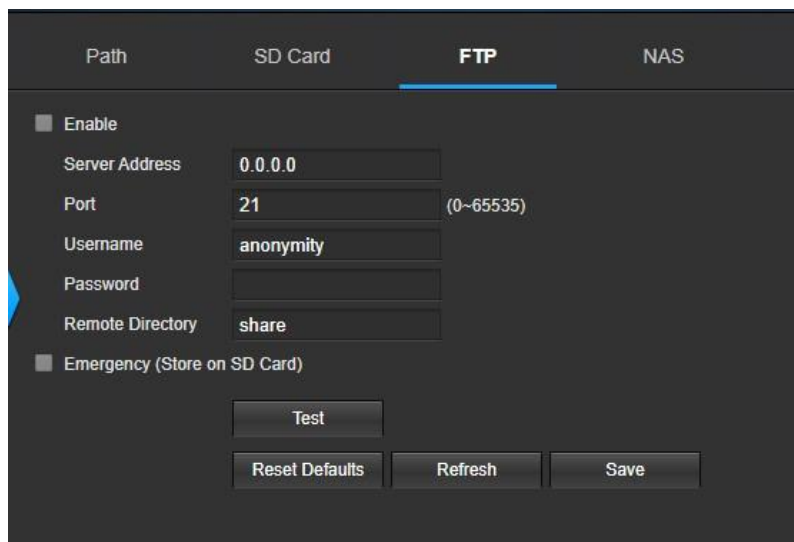

The screenshot shows a dark-themed interface with four tabs: Path, SD Card, FTP (selected), and NAS. The FTP settings are as follows:

- Enable
- Server Address: 0.0.0.0
- Port: 21 (0~65535)
- Username: anonymity
- Password: [Empty field]
- Remote Directory: share
- Emergency (Store on SD Card)

At the bottom, there are three buttons: Test, Reset Defaults, Refresh, and Save.

Below is an explanation of the fields on the FTP settings tab:

Enable: This checkbox allows the user to enable FTP uploading for the camera's recorded media.

Server Address: This field allows the user to designate a DDNS address for the FTP server.

Port: This field allows the user to designate the port number for the FTP server.

Username: This field allows the user to input the username used to login to the FTP server.

Password: This field allows the user to input the password used to login to the FTP server.

Remote Directory: This field allows the user to specify a remote directory on the FTP to send the recorded media to.

Emergency (Store on SD Card): This checkbox allows the camera to store recorded media on the SD card in case the FTP server is unavailable.

To reset to default settings, click the **Reset Defaults** button. To refresh the page, click the **Refresh** button. To save the settings, click the **Save** button.

NAS

This tab is where the user can change NAS settings. Below is a screenshot of the NAS tab:

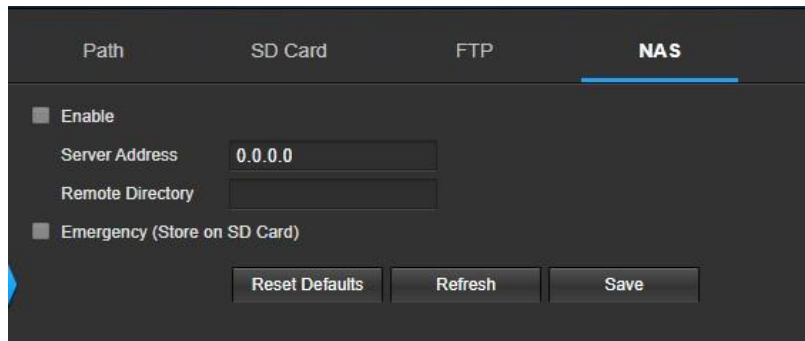

The screenshot shows the NAS settings tab with the following fields and controls:

- Enable:** A checkbox that is currently unchecked.
- Server Address:** A text input field containing "0.0.0.0".
- Remote Directory:** An empty text input field.
- Emergency (Store on SD Card):** A checkbox that is currently unchecked.
- Buttons:** Three buttons at the bottom: "Reset Defaults", "Refresh", and "Save".

Below is an explanation of the fields on the NAS settings tab:

Enable: This checkbox allows the user to enable NAS uploading for the camera's recorded media.

Server Address: This field allows the user to designate a DDNS address for the NAS server/device.

Remote Directory: This field allows the user to specify a remote directory on the NAS to send the recorded media to.

To reset to default settings, click the **Reset Defaults** button. To refresh the page, click the **Refresh** button. To save the settings, click the **Save** button.

Record Control

This menu is where general recording settings are configured. Below is a screenshot of the record control menu:

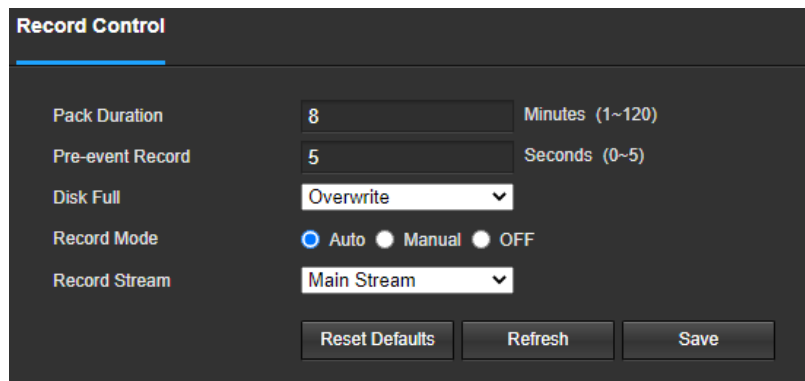

The screenshot shows the Record Control settings tab with the following fields and controls:

- Pack Duration:** A text input field containing "8" with the unit "Minutes (1~120)".
- Pre-event Record:** A text input field containing "5" with the unit "Seconds (0~5)".
- Disk Full:** A dropdown menu currently set to "Overwrite".
- Record Mode:** Three radio buttons: "Auto" (selected), "Manual", and "OFF".
- Record Stream:** A dropdown menu currently set to "Main Stream".
- Buttons:** Three buttons at the bottom: "Reset Defaults", "Refresh", and "Save".

Below is an explanation of the fields on the Record Control settings tab:

Pack Duration: This field allows the user to set how many minutes each file is comprised of.

Pre-event Record: This field allows the user to specify how many seconds before an event should be recorded.

Disk Full: This dropdown box allows the user to designate what the camera should do when the disk is full. There are 2 options: Overwrite or Stop.

Record Mode: This set of radio buttons allows the user to designate the recording mode. The options are Auto, Manual, and Off.

Record Stream: This dropdown box allows the user to specify which stream to record. The options are mainstream and sub stream.

To reset to default settings, click the **Reset Defaults** button. To refresh the page, click the **Refresh** button. To save the settings, click the **Save** button.

Cloud Storage

This menu redirects the user to the Amcrest Cloud web site. At this website (amcrestcloud.com) users can register for new accounts as well as view or modify existing accounts.

For more information on Amcrest Cloud visit: amcrestcloud.com

System

This menu section allows the user to change general settings for the camera.

General

This menu controls where general settings are configured. There are 2 tabs in this menu: General and Date & Time.

General

This tab is where the user can configure some basic camera settings. Below is a screenshot of the General tab:

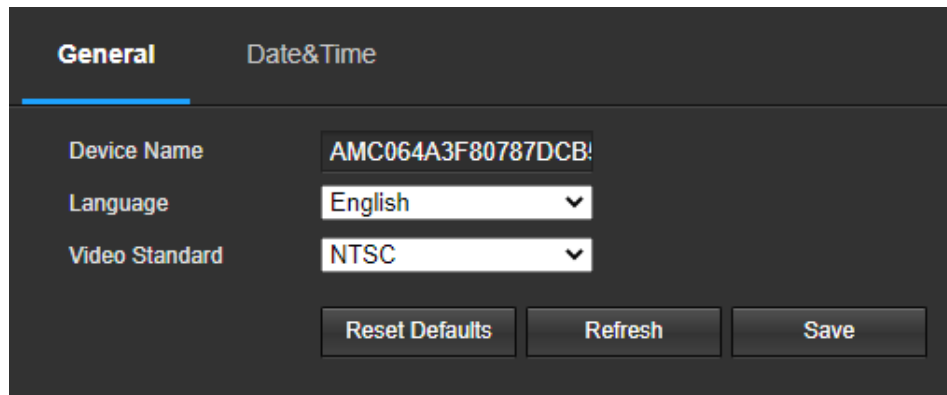

Below is an explanation of the fields on the General settings tab:

Device Name: This field allows the user to change the device's name.

Language: This dropdown box allows the user to change the language used in the camera.

Video Standard: This dropdown box allows the user to select either the NTSC or PAL video standard.

To reset to default settings, click the **Reset Defaults** button. To refresh the page, click the **Refresh** button. To save the settings, click the **Save** button.

Date & Time

This tab is where the user can configure the date and time settings for the camera. Below is a screenshot of the Date & Time tab:

Below is an explanation of the fields on the **Date & Time** settings tab:

Date Format: This dropdown box allows the user to change the date format used in the camera.

Time Format: This dropdown box allows the user to change the time format used in the camera.

Time Zone: This dropdown box allows the user to change the time zone used in the camera.

Current Time: This field allows the user to enter in the date and time manually. Clicking the PC Sync button allows the camera to sync with a Network Time Protocol (NTP) server.

Enable DST: This checkbox allows the user to enable daylight savings time for the camera.

DST Type: This radio button allows the user to select whether DST is based on the week, or a specific day.

Start Time: This dropdown box and field allow the user to enter in the start time for DST.

End Time: This dropdown box and field allow the user to enter in the end time for DST.

Synchronize with NTP: This checkbox allows the user to enable the camera's synchronization with an NTP server.

NTP Server: This field allows the user to enter in an NTP server.

Port: This field allows the user to enter in the port number for the NTP server.

Update Period: This field allows the user to enter in the update period time. This number designates how frequently the camera pings the NTP server to ensure it has the correct time. The range is from 0-30 minutes.

To reset to default settings, click the **Reset Defaults** button. To refresh the page, click the **Refresh** button. To save the settings, click the **Save** button.

Manage Users

This menu allows the user to change the user accounts on the camera. By default, the camera only has the admin account which has all rights/authorities. Additional accounts can be created on this screen. Below is a screenshot of the account screen:

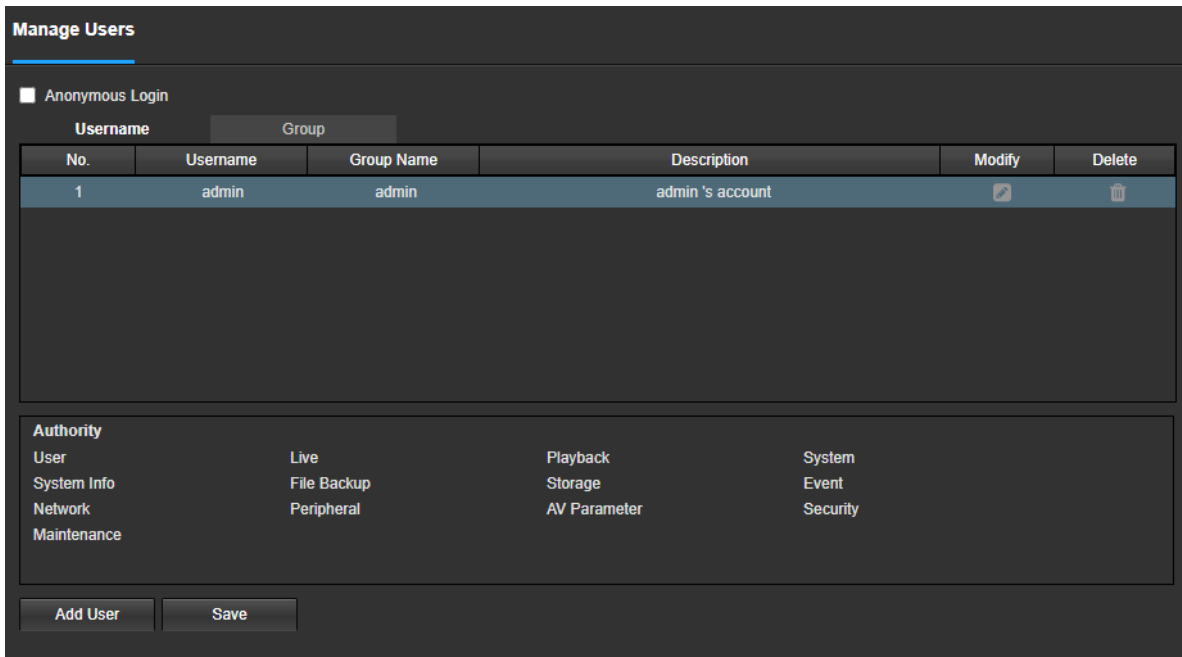

Below is an explanation of the fields on the Account screen:

Anonymous Login: This checkbox allows the user to enable the anonymous login feature. This allows all user account names to remain hidden on this screen.

Username: This tab shows the usernames available on the camera.

Group: This tab shows the user groups available on the camera.

No.: This column shows the user's number on the user list.

Username: This column shows the usernames of the different accounts on the camera.

Group Name: This column shows the group of the different accounts on the camera.

Description: This column shows a description of the account.

Modify: This column allows the user to modify the user account.

Delete: This column allows the user to delete a user account. Note: The admin account cannot be deleted.

Authority List: This box shows which user rights/authorities are assigned to an account.

Add User: This button allows the user to add a new user to the camera.

Default Settings

This screen allows the user to reset the camera and all its settings to the factory settings.

Below is a screenshot of the Default screen:

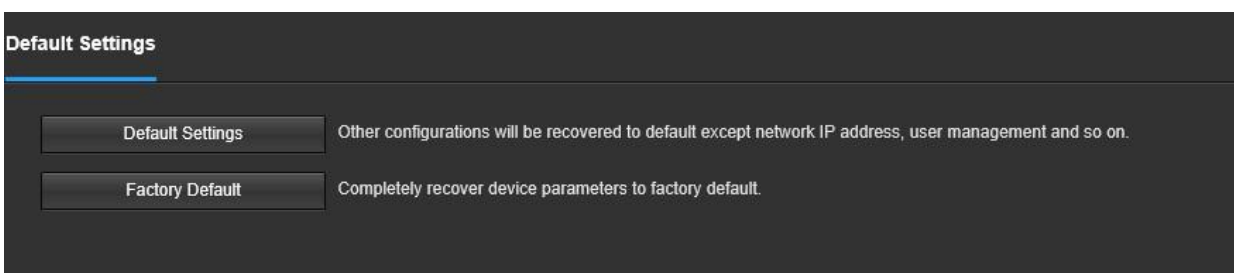

Below is an explanation of the items listed in this field:

Default Settings: Only the IP address, user management, and other settings can be recovered after reset. **Factory Default:** Completely resets the camera to factory default settings. No settings can be recovered after the camera has been returned to its factory default settings.

Import/Export

This screen allows the user to import or export settings from the camera. Below is a screenshot of the Import/Export screen:

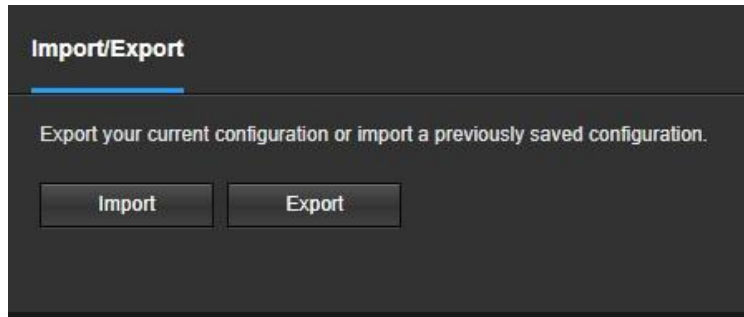

To import settings, click the Import button. To export settings, click the Export button.

Auto Maintain

This screen allows the user to set auto maintenance settings for the camera. Below is a screenshot of the Auto Maintain screen:

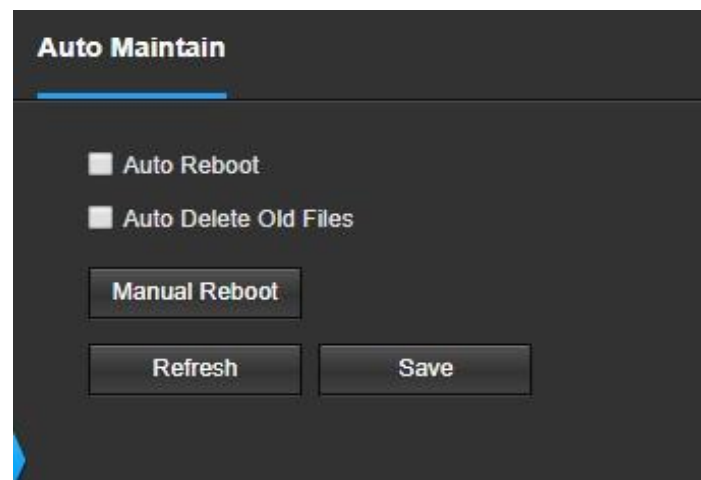

Below is an explanation of the fields on the Auto Maintain screen:

Auto Reboot: This checkbox allows the user to enable the auto reboot function. The dropdown box and field to the right of this checkbox allow the user to specify what date and time of the week the camera will auto reboot.

Auto Delete Old Files: This checkbox allows the user to enable the auto deletion of old files on the camera.

Manual Reboot: This button allows the user to manually reboot the camera.

To refresh the page, click the **Refresh** button. To save the settings, click the **Save** button.

Upgrade

This menu allows the user to upgrade the camera's firmware. Below is a screenshot of the Upgrade screen:

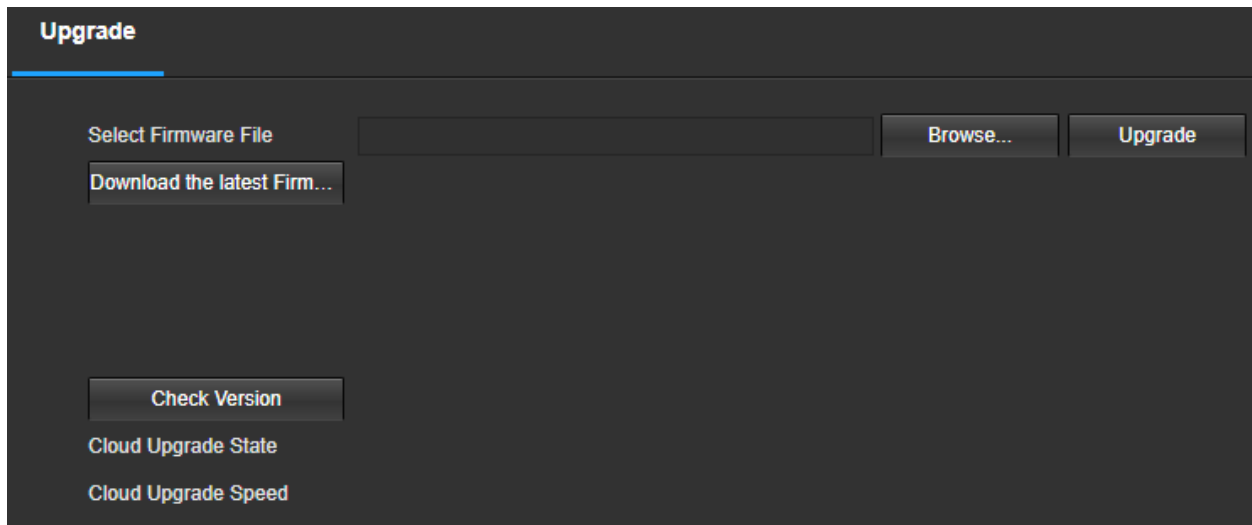

To upgrade the firmware for your camera, follow the steps provided below:

Go to amcrest.com/firmware-subscribe

Search for the model number of your camera and download the latest firmware file.

Return to the web user interface for your camera and press the **Browse** button to locate and import the firmware file you just downloaded.

Once the firmware file has been imported, click **Upgrade**.

The device will reset, return to the web user interface. The upgrade is now complete.

Note: When upgrading the camera's firmware, do not disconnect the internet or power from the camera.

Information

This menu section allows the user to view information about the camera for reference purposes.

Version

This screen allows the user to see various information about the camera's software versions, as well as other information.

On this screen, software version, web interface version, and ONVIF version are displayed. Also, the S/N (Token ID) is displayed here.

Log

This screen is where the camera's activity log is kept. Below is a screenshot of the Log screen:

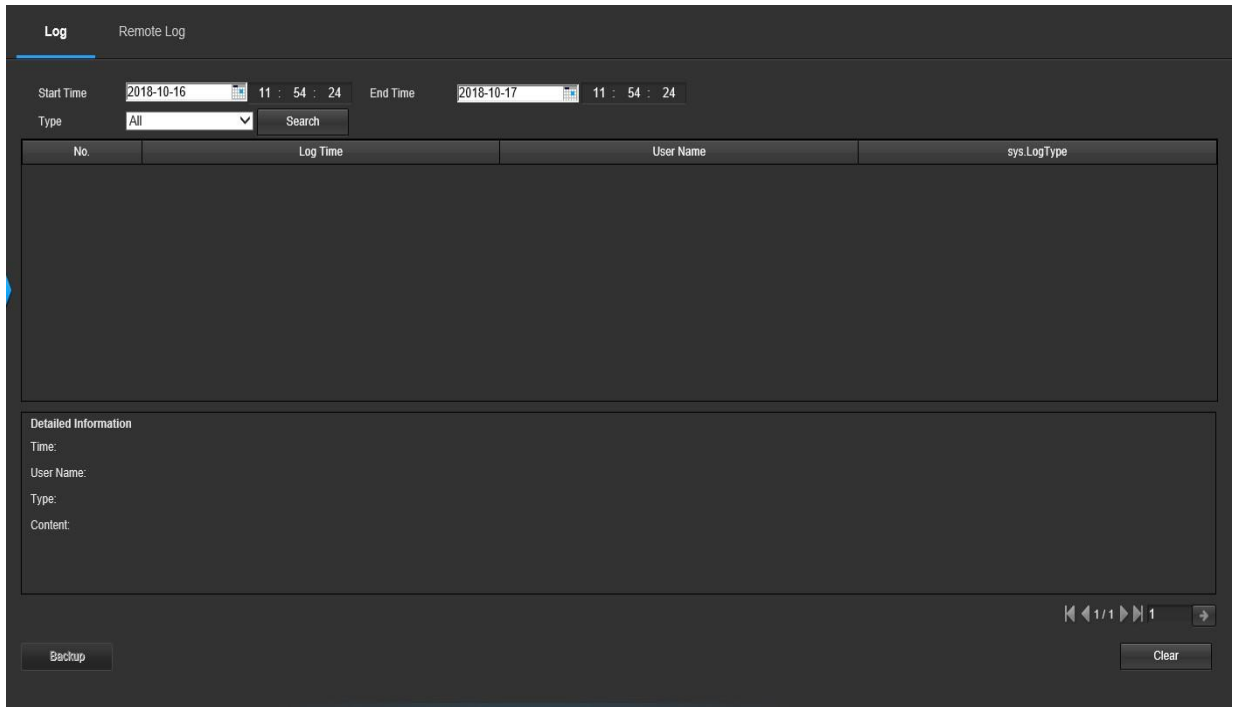

To view logs for a specific time period, modify the start time and end time fields, choose the type of event (system, setting, data, event, record, manage users, clear log), and click search.

To back up the log, click the Backup button. To clear the log, click the **Clear** button.

Remote Log

The Remote Log menu allows users to retain log information from other remotely connected devices. Below is a screenshot of the Remote Log menu:

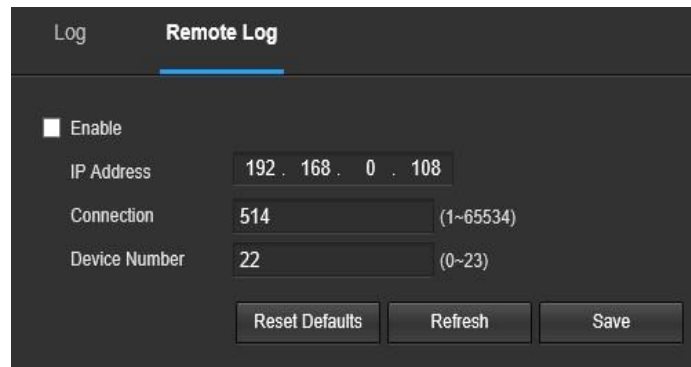

Enable: Enables the remote log feature.

IP Address: The IP address of the remote device

Connection: The port number set for the remote device (1~65534) **Device Number:** The number of the device in the network segment.

To reset to default settings, click the **Reset Defaults** button. To refresh the page, click the **Refresh** button. To save the settings, click the **Save** button.

Online Users

This screen allows the user to see which users are online. Below is a screenshot of the Online Users screen:

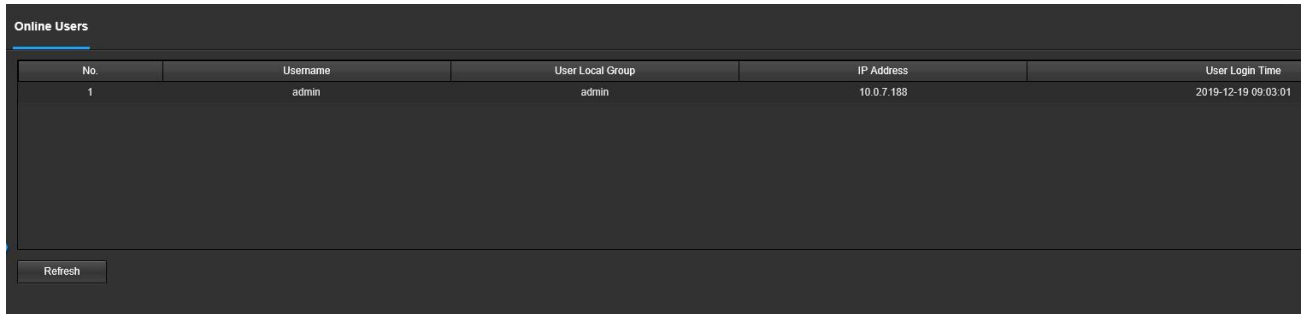

The screenshot shows the 'Online Users' interface. It features a table with the following columns: No., Username, User Local Group, IP Address, and User Login Time. A single row is visible with the following data: No. 1, Username admin, User Local Group admin, IP Address 10.0.7.188, and User Login Time 2019-12-19 09:03:01. Below the table is a 'Refresh' button.

No.	Username	User Local Group	IP Address	User Login Time
1	admin	admin	10.0.7.188	2019-12-19 09:03:01

Click **Refresh** to refresh this table.

Alarm

This screen is where the alarm log is kept. Below is a screenshot of the alarm screen:

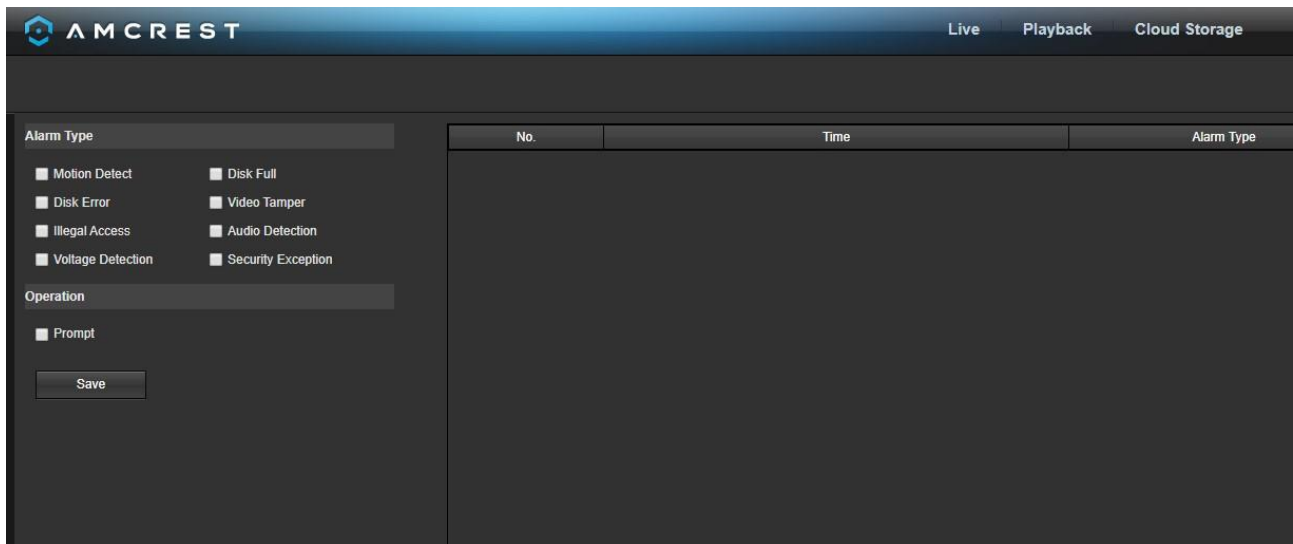

The screenshot shows the 'Alarm' configuration screen. On the left, there are two sections: 'Alarm Type' and 'Operation'. The 'Alarm Type' section contains checkboxes for: Motion Detect, Disk Error, Illegal Access, Voltage Detection, Disk Full, Video Tamper, Audio Detection, and Security Exception. The 'Operation' section contains a checkbox for 'Prompt'. A 'Save' button is located below the 'Operation' section. On the right, there is a table with columns: No., Time, and Alarm Type. The table is currently empty.

The table on the right shows the alarm log and all the alarm instances that have occurred.

The checkboxes allow the user to narrow down which alarms they want to see in the alarm log. Clicking the checkbox next to Prompt will cause the system to pop up a dialog box anytime an alarm is triggered. Clicking the checkbox next to Play Custom Alarm will use a custom alarm sound for the alarm prompt. Click the Browse button to search for a custom alarm sound to use.

Logout

Clicking the logout button will log out the user.

Remote Web Access Setup

There are two main methods for setting up remote access: UPnP/DDNS, and Port Forwarding.

UPnP/DDNS Remote Web Access Setup

Using Universal Plug and Play (UPnP) and Dynamic Domain Name Server (DDNS) functionality is the easiest way to setup stable remote access. For this method, your router should support the uPnP networking protocol and the protocol should be enabled. Please refer to your router manufacturer's documentation to learn how to enable uPnP on your router.

Below is a step-by-step walkthrough that details how to setup Amcrest cameras for Remote Web Access using UPnP and DDNS:

1. Login to your camera's web interface, open the main menu then go to Setup -> Network.
2. Using the left-hand menu, go to the Connection menu, and write down the HTTP port. It is recommended to ensure the port number is at least 5 digits long to prevent any port conflicts. If need be, change the port to a 5digit number that is less than 65535, note the number down, and click save before proceeding to the next step.
3. The system will prompt you to reset the camera. Click OK and wait for the camera to restart.
4. Restarting the camera may cause the device to use another IP address. Use the included IP Config tool to find the IP address as detailed previously in this document.
5. Login to your camera, open the main menu then go to Setup -> Network.
6. Click the Connections menu item on the left-hand menu and ensure that the HTTP port has changed.
7. Click the DDNS menu item on the left-hand menu, pick Amcrest DDNS from the drop-down box, click the checkbox next to Server Type, and then click the Save button on the bottom right.
8. To set a custom DDNS name, fill out the Domain Name field and click Save.
9. Write down the entire Domain Name field, including the white text that says.AmcrestDDNS.com
10. Click the UPnP menu item on the left-hand menu and click the enable checkbox at the top.
11. While in the UPnP menu, double click the HTTP port, and change both the internal and external HTTP ports to match the number that was used in step 2.
12. Uncheck the last 4 checkboxes in the PAT table on the UPnP menu.
13. Click apply, then exit this menu to go back to the main menu, then re-enter the UPnP menu, and ensure the UPnP status says, "Mapping Successful".
14. Open a web browser and enter in the DDNS domain name address from step 9, enter in a colon, then type the port number from step 4 on to the end.
 - a. For example, if the DDNS domain name is <http://abc123456789.AmcrestDDNS.com> and your HTTP Port is 33333, the URL would be <http://abc123456789.AmcrestDDNS.com:33333>
15. The browser may prompt you to install a plugin. Click install to download the plugin, and then click on the plugin installation file to install the plugin.
16. If the browser prompts you to allow the plugin to work on the computer, hit Allow to ensure the plugin can run successfully.
17. Enter in login details into the username and password fields and click login.

If the process above is not working, please contact Amcrest Support via one of the following options:

Visit <http://amcrest.com/contacts> and use the email form.

Call Amcrest Support using one of the following numbers

Toll Free: (888) 212-7538

International Callers (Outside of US): +1-713-893-8956

USA: (888) 212-7538

Canada: 437-888-0177

UK: 203-769-2757

Email Amcrest Customer Support support@amcrest.com



Port Forwarding Remote Web Access Setup

Port Forwarding is an alternative method to setting up remote access for Amcrest cameras. This method should only be used if the UPnP/DDNS Remote Access method did not work.

Below is a step-by-step walkthrough that details how to setup the camera for Remote Web Access using Port Forwarding:

1. Login to your camera, open the main menu then go to Setup -> Network.
2. Open the TCP/IP settings screen.
3. By default, the camera has the mode set to DHCP. Ensure that DHCP is selected. The IP Address, Subnet Mask, Default Gateway, Preferred DNS, and Alternate DNS should all be 0s if DHCP is selected.
4. Click Save to save these settings. This should now open the main menu.
5. From the main menu, go to **Setup -> Network**.
6. On the TCP/IP settings screen, the IP Address, Subnet Mask, Default Gateway, Preferred DNS, and Alternate DNS should all be populated.
7. Click the radio button next to Static, to change the mode to Static.
8. Write down the IP Address that is currently in the IP address field.
9. Click the **Save** button.
10. Using the left-hand menu, go to the Connection menu, and write down the TCP, UDP, and HTTP port number. It is recommended to ensure that these port numbers are at least 5 digits long to prevent any port conflicts. If need be, change each of these port numbers to a 5-digit number that is less than 65535, note the numbers down, and click save before proceeding to the next step.
11. Go to <http://www.canyouseeme.org/> and check to ensure each of the port numbers specified in step 10 is open.
12. Write down the manufacturer name, brand, and model name for the router that the camera is connected to, and then proceed to <http://www.portforward.com> on your web browser.
13. Open the port forwarding guide section on the left-hand side menu.
14. Find the router brand name in the list and click it.
15. Find the router model number and click it.
16. Click the Default Guide link near the middle of the page.
17. This guide will help you take the step necessary to port forward on the router. Follow these steps, and then return to the camera.
18. Login to your camera, open the main menu then go to Setup -> Network.
19. Click the DDNS menu item on the left-hand menu, pick AMCRESTDDNS from the drop-down box, click the checkbox next to Server Type, and then click the Save button on the bottom right.
20. To set a custom DDNS name, fill out the Domain Name field and click Save.
21. Write down the entire Domain Name field, including the white text that says AmcrestDDNS.com
22. Open a web browser and enter in the DDNS domain name address from step 21, enter in a colon, then type the HTTP port number from step 10 on to the end.
For example, if the DDNS domain name is <http://abc123456789.AmcrestDDNS.com> and your HTTP Port is 33333, the URL would be <http://abc123456789.AmcrestDDNS.com:33333>
23. Enter in login details into the username and password fields and click login.

If the process above is not working, please contact Amcrest Support via one of the following options:

Visit <http://amcrest.com/contacts> and use the email form

Call Amcrest Support using one of the following numbers

Toll Free: (888) 212-7538

International Callers (Outside of US): +1-713-893-8956

USA: (888) 212-7538



Canada: 437-888- 0177

UK: 203-769-2757

Email Amcrest Customer Support support@amcrest.com

Amcrest Cloud Desktop Setup

Amcrest cameras can sync with Amcrest Cloud; a service that stores recorded video streams to enable long-term storage. Amcrest Cloud also allows the user to easily find and download recorded video for playback from any internet connected PC or Mac computer.

For more information on how to setup your camera on Amcrest Cloud please follow the steps provided below:

1. Connect the camera to power and wait 30 seconds for the camera to start-up and initialize.
2. Using a web browser on your PC or Mac, visit www.amcrest.com/cloud and register for a cloud account. Once registered, click the “Add Camera” button. Select “Amcrest”, give the camera a name, and enter the camera’s SN (located on the bottom of the camera), then click “Next”.
3. On the settings page, you can adjust optional preferences for your camera. Once settings have been adjusted, click “Finish”. Your camera is now successfully set up for cloud access and storage.
4. View your camera live or watch recorded clips using the menu button on the top of the page. You can also use the Amcrest Cloud app on iOS and Android to add more cameras, play recordings, and view your camera live, from anywhere. For more information visit amcrest.com/support
5. For additional assistance, please contact us at www.amcrest.com or give us a call at 1-888-212-7538. Step by step video tutorials available at <http://www.amcrest.com/videos>

Web Access Setup (AmcrestView.com)

1. Connect the camera to power and wait 30 seconds for the camera to start-up and initialize.
 2. Using Internet Explorer or Safari, go to www.AmcrestView.com and register an account. You will be required to activate your account by e-mail (double-check your spam folder).
 3. Once activated, download, and install the plugin for your web browser. The installation of the plugin will require all web browsers to close.
 4. Log in to your account. To add a camera, click the “Add Device” button. Give the camera a name, enter the UID (found on the bottom of your camera), then enter the login details for the camera. The default username and password for the camera is admin.
 5. Once added, the camera should appear in the device list. Click the  icon next to the camera’s UID to open the live viewing and playback interface.
 6. The device is now successfully setup for live viewing and playback!
- For additional assistance, please contact us at www.amcrest.com or give us a call at 1-888-212-7538. Step by step video tutorials available at www.amcrest.com/videos

FAQs/Troubleshooting

1. The camera does not boot up properly.

Below are a few possible reasons why this may be occurring:

- The power input is not correct voltage.
- The power cable connection is not secured correctly.
- The firmware was upgraded incorrectly.

2. Camera often automatically shuts down or stops running.

Below are a few possible reasons why this may be occurring:

- The input voltage is too low or is not stable.
- The insides of the camera have accumulated too much dust.
- The temperature is either too hot or too cold.
- The hardware is malfunctioning.

3. Real-time video color is distorted.

Below are a few possible reasons why this may be occurring:

- The camera is not compatible with the monitor.
- The camera color or brightness settings are not correctly configured.

4. The timestamp is not displaying the correct time.

The time and date settings may not be configured correctly. You can take the following steps to resolve the issue:

- Log into your camera's web user interface via a laptop or PC.
- Navigate to **Setup>>System>>General**
- Click on the **Date & Time** tab.
- Click on **PC Sync** to sync the date and time.
- Click **Save** to save and apply the new date and time settings.

5. Motion detection does not work.

Below are a few possible reasons why this may be occurring:

- The motion detection time period may be incorrectly configured.
- Motion detection zone setup is not correctly configured.
- Motion detection sensitivity is too low.

6. Web Access is not working.

Below are a few possible reasons why this may be occurring:

- Windows version is pre -Windows 2000 service pack 4. Use a more recent version of Windows.
- ActiveX controls have been disabled.
- The PC is not using DirectX 8.1 or higher. Upgrade to a more recent version of DirectX.
- The camera is having network connection errors.
- Web access may be setup incorrectly.
- The username or password may be incorrect.

7. Web Access live view is only displaying a static picture.

Below are a few possible reasons why this may be occurring:

- The network speed is not enough to transfer video data via web access.
- The client PC may have limited resources.
- Multicast mode may be causing this issue.
- A privacy mask or screensaver may be enabled.
- The logged in user may not have enough rights to monitor real-time playback.
- The camera's local video output quality is not enough.

8. Network connection is not stable.

Below are a few possible reasons why this may be occurring:

- The network is not stable.
- There may be an IP address conflict.

- There may be a MAC address conflict.
- The PC or camera network card may be defective.
- The Ethernet cable is too long

9. The alarm signal cannot be disarmed.

Below are a few possible reasons why this may be occurring:

- An alarm may be setup incorrectly.
- An alarm output may have been manually opened.
- There may be an error in the camera's firmware.

10. Alarms are not working.

Below are a few possible reasons why this may be occurring:

- The alarm is not setup correctly.
- The alarm cable is not connected correctly.
- The alarm input signal is not correctly configured.
- There are two loops connected to one alarm device.

11. Downloaded files cannot be played back.

Below are a few possible reasons why this may be occurring:

- The media player software on the PC may not be able to read the file format.
- The PC may not have DirectX 8.1 or higher.
- The PC may not have Windows XP or higher.

12. When I login via HTTPS, a dialogue says the certificate has expired or is not valid yet.

- Ensure the PC has the same time as the camera's system time.

Glossary of Terms

- Abnormality – Any malfunction in terms of storage of data to the SD card.
- Alarm Delay – The gap in time between alarm activation and Relay alarm activation.
- Alternate Gateway – The node on the computer network that the network software uses when an IP address does not match any other routes in the routing table, and when the default gateway is not available.
- Anti-Dither – This time value controls how long the alarm signal lasts. The values in this field can range from 5 to 600 seconds. Based on motion detection, a buzzer can go off, a tour can begin, a snapshot can be taken, or the camera can begin recording.
- DDNS – Stands for Dynamic Domain Name System. DDNS is a method of automatically updating a name server in the Domain Name System (DNS), often in real time, with the active DNS configuration of its configured hostnames, addresses or other information.
- Default Gateway – The node on the computer network that the network software uses when an IP address does not match any other routes in the routing table.
- DHCP – Dynamic Host Configuration Protocol is a network protocol that enables a server to automatically assign an IP address to a computer from a defined range of numbers (i.e., a scope) configured for a given network.
- Fluency – Fluency described the lack of stuttering or excessive delay in a video stream. Fluency usually comes at the expense of video quality when a network is constrained.
- IP Address – Internet Protocol Address is a unique numerical label assigned to each device connected to a computer network. The IP address allows communication between different devices on a network.
- Main Stream – Main Stream is the main streaming protocol for the camera. Main stream uses more bandwidth and attempts to keep quality and fluency high.

- NO/NC – Normally Open and Normally Closed are options for sensor type. These settings allow for different exposure types when capturing video and still images.
- NTP – Network Time Protocol is a networking protocol for clock synchronization between computer systems over packet-switched, variable-latency data networks.
- P2P – Peer-to-Peer is a decentralized communications model in which each party has the same capabilities and either party can initiate a communication session.
- PPPoE – Point to Point Protocol over Ethernet is a network protocol for encapsulating Point to Point Protocol data packets inside Ethernet frames.
- QR Code – Quick Response code is a type of digital barcode that enables devices to share complex data strings quickly.
- Record Delay – Record Delay specifies in seconds how long the delay between alarm activation and recording should be.
- Relay Out – Relay Out triggers a connected alarm (connected to the alarm port on the back of the camera) when an alarm on the camera is triggered.
- S/N – S/N stands for serial number. The S/N is unique to each camera and can be used to connect to different Amcrest apps and services to provide different methods of access to the camera.
- Sensitivity – Sensitivity is the amount of change required to increase the motion detected by a percentage. The lower the sensitivity, the more movement is required to trigger an alarm.
- SMTP – Simple Mail Transfer Protocol is an Internet standard for electronic mail (e-mail) transmission.
- Static IP – An IP address that does not change.
- Sub Stream – Sub Stream is an alternative streaming protocol for the camera. Sub stream uses less bandwidth and attempts to keep fluency high at the expense of quality.
- Subnet Mask – a 32-bit number that masks an IP address, and divides the IP address into network address and host address.
- TCP/IP – TCP/IP stands for Transmission Control Protocol/Internet Protocol and it is the language/protocol that allows communication between internet connected devices, whether on a local network, or a on the Internet at large.
- Threshold – Threshold is the level that the motion detection needs to reach to trigger an alarm.
- UPnP – UPnP stands for Universal Plug and Play, and it is a protocol used to easily connect devices to the internet.
- Video Tamper – Video Tamper refers to any major changes happening to the video feed such as it being blocked out, interfered with, or disconnected.

FCC Statement

1. This device complies with Part 15 of the FCC Rules. Operation is subject to the following two conditions: (1) this device may not cause harmful interference, and (2) this device must accept any interference received, including interference that may cause undesired operation.
2. The user's manual or instruction manual for an intentional or unintentional radiator shall caution the user that changes, or modifications not expressly approved by the party responsible for compliance could void the user's authority to operate the equipment. In cases where the manual is provided only in a form other than paper, such as on a computer disk or over the Internet, the information required by this section may be included in the manual in that alternative form, provided the user can reasonably be expected to have the capability to access information in that form.
3. (b) For a Class B digital device or peripheral, the instructions furnished the user shall include the following or similar statement, placed in a prominent location in the text of the manual: NOTE: This equipment has been tested and found to comply with the limits for a Class B digital device, pursuant to Part 15 of the FCC Rules. These limits are designed to provide reasonable protection against harmful interference in a residential installation. This

equipment generates, uses and can radiate radio frequency energy and, if not installed and used in accordance with the instructions, may cause harmful interference to radio communications. However, there is no guarantee that interference will not occur in a particular installation. If this equipment does cause harmful interference to radio or

television reception, which can be determined by turning the equipment off and on, the user is encouraged to try to correct the interference by one or more of the following measures: -- Reorient or relocate the receiving antenna. -- Increase the separation between the equipment and receiver. -- Connect the equipment into an outlet on a circuit different from that to which the receiver is connected. -- Consult the dealer or an experienced radio/TV technician for help.

4. RF exposure warning This equipment must be installed and operated in accordance with provided instructions and the antenna(s) used for this transmitter must be installed to provide a separation distance of at least 20 cm from all persons and must not be co-located or operating in conjunction with any other antenna or transmitter.

End-users and installers must be provided with antenna installation instructions and transmitter operating conditions for satisfying RF exposure compliance.

IC Warning Statement

This device complies with Industry Canada's licence-exempt RSSs. Operation is subject to the following two conditions: (1) This device may not cause interference; and (2) This device must accept any interference, including interference that may cause undesired operation of the device. Le présent appareil est conforme aux CNR d'Industrie Canada applicables aux appareils radio exempts de licence. L'exploitation est autorisée aux deux conditions suivantes : (1) l'appareil ne doit pas produire de brouillage, et (2) l'utilisateur de l'appareil doit accepter tout brouillage radioélectrique subi, même si le brouillage est susceptible d'en compromettre le fonctionnement. This equipment complies with IC RSS-102 radiation exposure limits set forth for an uncontrolled environment. This equipment should be installed and operated with a minimum distance of 20cm between the radiator and any part of your body. Pour se conformer aux exigences de conformité CNR 102 RF exposition, une distance de séparation d'au moins 20 cm doit être maintenue entre l'antenne de cet appareil et toutes les personnes.

Appendix A: Toxic or Hazardous Materials or Elements

Component Name	Toxic or Hazardous Materials or Elements					
	Pb	Hg	Cd	Cr VI	PBB	PBDE
Sheet Metal	○	○	○	○	○	○
Plastic Parts	○	○	○	○	○	○
Circuit Board	○	○	○	○	○	○
Fastener	○	○	○	○	○	○
Wire and Cable/Ac Adapter	○	○	○	○	○	○
Packing Material	○	○	○	○	○	○
Accessories	○	○	○	○	○	○

O: Indicates that the concentration of the hazardous substance in all homogeneous materials in the parts is below the relevant threshold of the SJ/T11363-2006 standard.

X: Indicates that the concentration of the hazardous substance of at least one of all homogeneous materials in the parts is above the relevant threshold of the SJ/T11363-2006 standard. During the environmental-friendly use period (EFUP) period, the toxic or hazardous substance or elements contained in products will not leak or mutate so that the use of these (substances or elements) will not result in any severe environmental pollution, any bodily injury or damage to any assets. The consumer is not authorized to process such kind of substances or elements, please return to the corresponding local authorities to process according to your local government statutes.

O: Indicates that the concentration of the hazardous substance in all homogeneous materials in the parts is below the relevant threshold of the SJ/T11363-2006 standard.

X: Indicates that the concentration of the hazardous substance of at least one of all homogeneous materials in the parts is above the relevant threshold of the SJ/T11363-2006 standard. During the environmental-friendly use period (EFUP) period, the toxic or hazardous substance or elements contained in products will not leak or mutate so that the use of these (substances or elements) will not result in any severe environmental pollution, any bodily injury or damage to any assets. The consumer is not authorized to process such kind of substances or elements, please return to the corresponding local authorities to process according to your local government statutes.

Note:

To view setup videos for many of the steps outlined in this guide, go to <http://amcrest.com/videos>

This user manual is for reference only. Slight differences may be found in the user interface.

All the designs and software here are subject to change without prior written notice.

All trademarks and registered trademarks mentioned are the properties of their respective owners.

To contact Amcrest support, please do one of the following:

Visit <http://amcrest.com/contacts> and use the email form

Call Amcrest Support using one of the following numbers:

Toll Free US: (888) 212-7538

International Callers (Outside of US): +1-713-893-8956

USA: 713-893-8956

Canada: 437-888-0177

UK: 203-769-2757

Email Amcrest Customer Support support@amcrest.com

Copyright Amcrest[©] 2020

